

Trademarks

Auro® and OtoSys® are trademarks of Shenzhen HC Tech CO., Ltd., registered in China, the United States and other countries. All other marks are trademarks or registered trademarks of their respective holders.

Copyright Information

No part of this manual may be reproduced, stored in a retrieval system or transmitted, in any form or by any means, electronic, mechanical, photocopying, recording, or otherwise without the prior written permission of Auro.

Disclaimer of Warranties and Limitation of Liabilities

All information, specifications and illustrations in this manual are based on the latest information available at the time of printing.

Auro reserves the right to make changes at any time without notice. While information of this manual has been carefully checked for accuracy, no guarantee is given for the completeness and correctness of the contents, including but not limited to the product specifications, functions, and illustrations.

Auro will not be liable for any direct, special, incidental, indirect damages or any economic consequential damages (including the loss of profits).

IMPORTANT

Before operating or maintaining this unit, please read this manual carefully, paying extra attention to the safety warnings and precautions.

For Services and Support

 www.aurodiag.com

 support@eurodiag.com

For technical assistance in all other markets, please contact your local selling agent.

Safety Information

For your own safety and the safety of others, and to prevent damage to the device and vehicles upon which it is used, it is important that the safety instructions presented throughout this manual be read and understood by all persons operating or coming into contact with the device.

There are various procedures, techniques, tools, and parts for servicing vehicles, as well as in the skill of the person doing the work. Because of the vast number of test applications and variations in the products that can be tested with this equipment, we cannot possibly anticipate or provide advice or safety messages to cover every circumstance. It is the automotive technician's responsibility to be knowledgeable of the system being tested. It is crucial to use proper service methods and test procedures. It is essential to perform tests in an appropriate and acceptable manner that does not endanger your safety, the safety of others in the work area, the device being used, or the vehicle being tested.

Before using the device, always refer to and follow the safety messages and applicable test procedures provided by the manufacturer of the vehicle or equipment being tested. Use the device only as described in this manual. Read, understand, and follow all safety messages and instructions in this manual.

Safety Messages

Safety messages are provided to help prevent personal injury and equipment damage. All safety messages are introduced by a signal word indicating the hazard level.

DANGER

Indicates an imminently hazardous situation which, if not avoided, will result in death or serious injury to the operator or to bystanders.

WARNING

Indicates a potentially hazardous situation which, if not avoided, could result in death or serious injury to the operator or to bystanders.

Safety Instructions

The safety messages herein cover situations Auro is aware of. Auro cannot know, evaluate or advise you as to all of the possible hazards. You must be certain that any condition or service procedure encountered does not jeopardize your personal safety.

DANGER

When an engine is operating, keep the service area **WELL VENTILATED** or attach a building exhaust removal system to the engine exhaust system. Engines produce carbon monoxide, an odorless, poisonous gas that causes slower reaction time and can lead to serious personal injury or loss of life.

SAFETY WARNINGS

- Always perform automotive testing in a safe environment.
- Wear safety eye protection that meets ANSI standards.
- Keep clothing, hair, hands, tools, test equipment, etc. away from all moving or hot engine parts.
- Operate the vehicle in a well ventilated work area, for exhaust gases are poisonous.
- Put the transmission in **PARK** (for automatic transmission) or **NEUTRAL** (for manual transmission) and make sure the parking brake is engaged.
- Put blocks in front of the drive wheels and never leave the vehicle unattended while testing.
- Be extra cautious when working around the ignition coil, distributor cap, ignition wires and spark plugs. These components create hazardous voltages when the engine is running.
- Keep a fire extinguisher suitable for gasoline, chemical, and electrical fires nearby.
- Do not connect or disconnect any test equipment while the ignition is on or the engine is running.
- Keep the test equipment dry, clean, free from oil, water or grease. Use a mild detergent on a clean cloth to clean the outside of the equipment as necessary.
- Do not drive the vehicle and operate the test equipment at the same time. Any distraction may cause an accident.

- Refer to the service manual for the vehicle being serviced and adhere to all diagnostic procedures and precautions. Failure to do so may result in personal injury or damage to the test equipment.
- To avoid damaging the test equipment or generating false data, make sure the vehicle battery is fully charged and the connection to the vehicle DLC is clean and secure.
- Do not place the test equipment on the distributor of the vehicle. Strong electro-magnetic interference can damage the equipment.

CONTENTS

1	USING THIS MANUAL.....	1
	CONVENTIONS	1
2	GENERAL INTRODUCTION.....	3
	OToSys IM100 DISPLAY TABLET	3
	UP200.....	8
3	GETTING STARTED	18
	POWERING UP	18
	POWERING DOWN.....	21
4	IMMO	23
	GETTING STARTED	23
	VEHICLE IDENTIFICATION.....	24
	NAVIGATION.....	27
	IMMO	31
5	PROGRAMMING.....	38
	PROGRAMMING	38
6	DIAGNOSTICS.....	42
	DIAGNOSIS	42
	GENERIC OBD II OPERATIONS	54
	EXITING DIAGNOSTICS	58
7	SERVICE OPERATIONS	60
	OIL RESET SERVICE.....	60
	ELECTRONIC PARKING BRAKE (EPB) SERVICE.....	63
	BMS	67
	STEERING ANGLE SENSOR (SAS) SERVICE	72
	DPF SERVICE.....	75
	TIRE PRESSURE MONITOR SYSTEM (TPMS) SERVICE.....	83
8	UPDATE.....	86
9	SETTINGS	89
	UNIT.....	89

LANGUAGE	90
PRINTING SETTING.....	90
FIRMWARE UPGRADE	91
NOTIFICATION CENTER	91
MULTITASK	92
AUTO UPDATE.....	92
SYSTEM SETTINGS.....	93
ABOUT.....	94
10 REMOTE DESK.....	95
11 DATA MANAGER	97
OPERATIONS	97
12 SHOP MANAGER.....	102
VEHICLE HISTORY.....	103
WORKSHOP INFORMATION	105
CUSTOMER MANAGER	106
13 MAINTENANCE AND SERVICE.....	110
MAINTENANCE INSTRUCTIONS.....	110
TROUBLESHOOTING CHECKLIST	111
ABOUT BATTERY USAGE.....	111
14 COMPLIANCE INFORMATION	113
15 WARRANTY	116
LIMITED ONE YEAR WARRANTY	116

1 Using this Manual

This manual contains device usage instructions.

Some illustrations shown in this manual may contain modules and optional equipment that are not included in your system.

Conventions

The following conventions are used.

Bold Text

Bold text is used to highlight selectable items such as buttons and menu options.

Example:

- Tap **OK**.

Notes and Important Messages

Notes

A **NOTE** provides helpful information such as additional explanations, tips, and comments.

Example:



NOTE

New batteries reach full capacity after approximately 3 to 5 charging and discharging cycles.

Important

IMPORTANT indicates a situation which, if not avoided, may result in damage to the tablet or vehicle.

Example:

! IMPORTANT

Keep the cable away from heat, oil, sharp edges and moving parts. Replace damaged cables immediately.

Hyperlink

Hyperlinks, or links, that take you to other related articles, procedures, and illustrations are available in electronic documents. Blue italic text indicates a selectable hyperlink and blue underlined text indicates a website link or an email address link.

Illustrations

Illustrations used in this manual are samples, the actual testing screen may vary for each vehicle being tested. Observe the menu titles and on-screen instructions to make correct option selection.

2 General Introduction

When it comes to ultra-portability, OtoSys IM100 is your perfect companion. Installed with a fast quad-core processor, IM100 offers maximum convenience and swift diagnosis. The intuitive user screen makes using the device effortless through a 7-inch LCD touchscreen that displays at 1024 x 600 quality. Together with the ability to quickly read and clear DTCs for all available modules of the majority of the makes and models on the market, IM100 provides you with superior special functions, including Oil Reset, EPB (Electronic Parking Brake), SAS (Steering Angle Sensor), BMS (Battery Management System), DPF (Diesel Particulate Filter), IMMO, and TPMS (Tire Pressure Monitoring System). What is more, together with the key programmer UP200, IM100 is capable of providing extraordinary service functions for the immobilizer system.

This manual describes the construction and operation of the device and how it works to deliver diagnostic solutions.

OtoSys IM100 Display Tablet

Functional Description

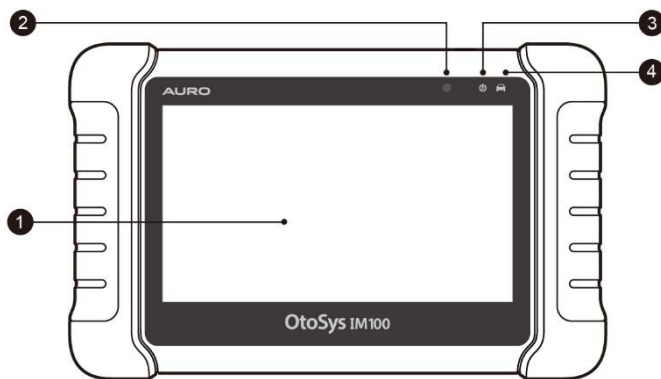

Figure 2-1 Display Tablet Front View

1. 7.0" LCD Capacitive Touchscreen

2. Ambient Light Sensor – detects ambient brightness.
3. Power LED – indicates battery level & charging or system status.
4. Vehicle Communication LED – flashes green when the Display Tablet is communicating/linking with the vehicle's system.

The power LED displays green, yellow or red depending on power level and operating state.

A. Green

- Illuminates green when the Display Tablet is charging and the battery level is above 90%.
- Illuminates green when the Display Tablet is powered on and the battery level is above 15%.

B. Yellow

- Illuminates yellow when the Display Tablet is charging and the battery level is below 90%.

C. Red

- Illuminates red when the Display Tablet is powered on and the battery level is below 15%.

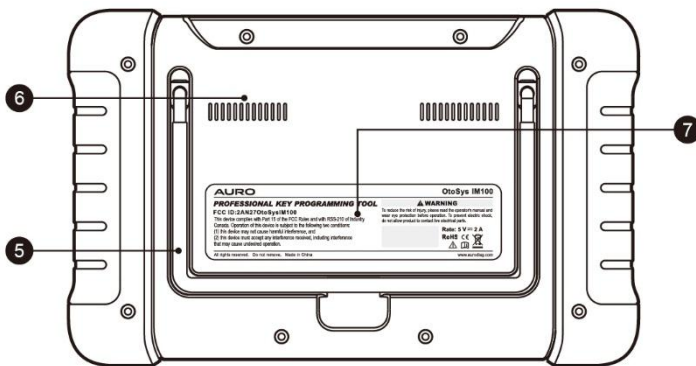

Figure 2-2 Display Tablet Back View

5. Collapsible Stand – extends from the back to allow hands-free viewing of the Display Tablet.
6. Heat Sink

7. Built-in Battery

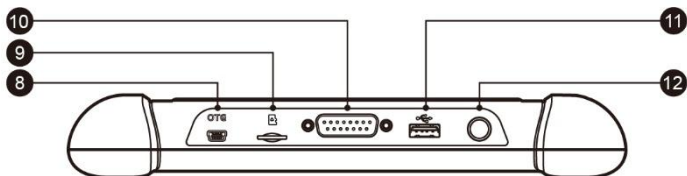

Figure 2-3 Display Tablet Top View

8. Mini USB OTG Port

9. Micro SD Card Slot – holds the micro SD card.

10. DB15-Pin Port – connects the main cable.

11. USB Port

12. Lock/Power Button – turns the device on & off with long press, or locks the screen with short press.

Power Sources

The Display Tablet can receive power from any of the following sources:

- Internal Battery Pack
- Vehicle Power
- External Power Supply

Internal Battery Pack

The Display Tablet can be powered with the internal rechargeable battery, which if fully charged can provide sufficient power for about 4.5 hours of continuous operation.

Vehicle Power

When the Display Tablet is connected to the test vehicle via the main cable, the Display Tablet automatically receives power from the vehicle.

External Power Supply

The Display Tablet can be powered from a wall socket using the mini USB cable and USB external power adapter. The external power supply also charges the internal battery pack.

Technical Specifications

Table 2-1 Specifications

Item	Description
Recommended Use	Indoor
Operating System	Android™ 4.4.4
Processor	Cortex-A9 processor (1.6 GHz)
Memory	32GB
Display	7-inch LCD capacitive touchscreen with 1024x600 resolution
Connectivity	<ul style="list-style-type: none"> ● Mini USB 2.0 ● USB 2.0 ● Wi-Fi ● Micro SD card (supports up to 32GB)
Sensors	Ambient light sensor for brightness auto changing
Audio Input/Output	<ul style="list-style-type: none"> ● Input: N/A ● Output: buzzer
Power and Battery	<ul style="list-style-type: none"> ● 3.7 V/5000 mAh lithium-polymer battery ● Charges via 5 VDC power supply
Tested Battery Life	Around 4.5 hours of continuous use
Battery Charging Input	5 V/1.5 A
Power Consumption	500 mA (LCD on with default brightness, Wi-Fi on) @3.7 V
Operating Temp.	0 to 55°C(32 to 131°F)
Storage Temp.	-20 to 60°C (-4 to 140°F)
Operating Humidity	5% - 95% non-condensing
Dimensions (W x H x D)	237.8 mm (9.4") x 148.6 mm (5.9") x 35.5 mm (1.4")

Item	Description
Net Weight	788 g (2.42 lb.)
Supported Automotive Protocols	ISO9141-2, ISO14230-2,ISO15765, K/L-Line, Flashing Code, SAE-J1850 VPW, SAE-J1850 PWM, ISO11898(Highspeed, Middlespeed, Lowspeed and Singlewire CAN,fault-tolerant CAN), SAE J2610,GM UART,UART Echo Byte Protocol, Honda Diag-H Protocol, TP2.0, TP1.6

Accessory Kit

Main Cable

The Main Cable connects the Display Tablet to the vehicle's data link connector (DLC).

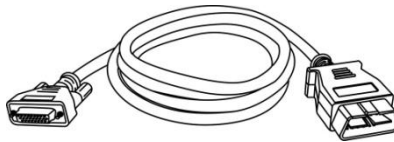

Figure 2-4 Main Cable

Other Accessories



Mazda-17 Adaptor



KIA-10 Adaptor



KIA-20 Adaptor



Honda-3 Adaptor



AAC001 – MED17 Cable

Mini USB Cable

Connects the Display Tablet to the PC or DC external power adapter.



USB External Power Adapter

Together with the mini USB cable, connects the Display Tablet to the external DC power port for power supply.

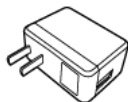

Quick Guide

Device connection and diagnostic software update instructions.

UP200

The UP200 is specially designed to read Volkswagen vehicle key chip data, clone and generate exclusive keys, read/write on-board EEPROM data, and read/write Freescale 9S12 MCUs. By working with diagnostic tool and PC that are both loaded with programmer software, the UP200 can read/write key chip data quickly and accurately.

Specifications

Table 2-2 Specifications

Item	Description
Operating Temperature	-10°C ~ 85°C (14°F ~ 185°F)
Storage Temperature	-20°C ~ 85°C (-4°F ~ 185°F)
Port	Mini USB, VGA_DB15
Input Voltage	5 VDC
Operating Current	< 250 mA
Maximum Consumption	1 W

Item	Description
Device Dimensions (L*W*H)	130 mm * 68 mm * 28 mm
Package Dimensions (L*W*H)	201 mm * 167 mm * 75 mm
Net Weight	466 g
Gross Weight	11 kg (20 pcs)

Accessories Included



APB001 – EEPROM Adaptor

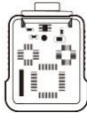

APB002 – 68HC908 Adaptor



APA002 – EEPROM Socket

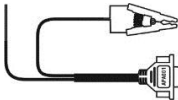

APA001 – EEPROM Clamp Integrated MC9S12 Cable

Components and Ports

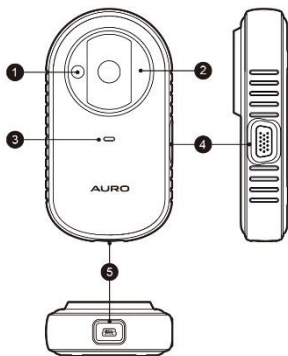

Figure 2-4 UP200 Views

1. Vehicle Key Chip Slot – holds the vehicle key chip.
2. Vehicle Key Slot – holds the vehicle key.
3. Status LED Light – indicates the current operating status.
4. Connection Port – connects EEPROM Adaptor and EEPROM Clamp Integrated MC9S12 Cable.
5. USB Port – provides data communication and power supply.

Vehicle Key Slot

Holds the Vehicle Key to read and write vehicle key information.

Vehicle Key Chip Slot

Holds the Vehicle Key Chip to read and write vehicle key chip information.

Status LED Light

The status LED of the UP200 indicates the operating status of the device. See [Table 2-3](#) for detailed description.

Table 2-3 Status LED Light on the Front Panel

LED Light	Color/Status	Description
Power	Solid Green	Powered on and Default Status
	Flashing Green	Communication Status
	Solid Red	Error Status

Connection Port

There are two accessories that can be paired with the connection port: EEPROM Clamp Integrated MC9S12 Cable and EEPROM Adaptor.

EEPROM Clamp Integrated MC9S12 Cable

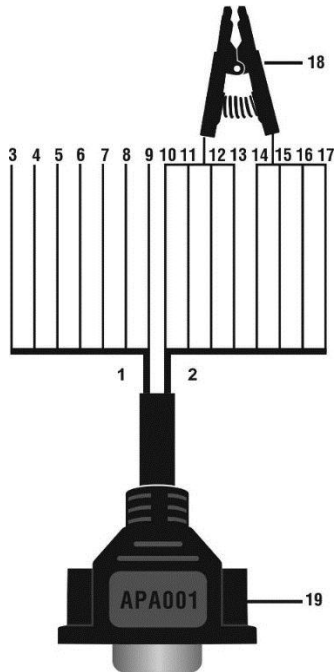

Figure 2-5 EEPROM Clamp Integrated MC9S12 Cable

1. MC9S12 Cable

Table 2-4 Definitions of MC9S12 Cable

No.	Color	Definition	Pin correspond to DB15	Note
3	Green	TXCLKS	1	
4	Black	GND	2	Shielded line
5	White	TOSC	6	Shielded line
6	Blue	TSW	7	
7	Brown	GND	8	
8	Yellow	TRESET	11	
9	Red	VDD	12	

2. EEPROM Clamp Cable

Table 2-5 Definitions of EEPROM Clamp Cable

No.	Color	Definition	Pin correspond to DB15	Note
10	White and Red	P1	5	Pin 1 is red
11	White and Purple	P2	15	
12	White and Blue	P3	10	
13	Grey	P4	4	
14	White and Brown	P5	14	
15	White and Green	P6	9	
16	White and Orange	P7	3	
17	White and Black	P8	13	Pin 8 is black

Here are the possible causes for EEPROM read/write failure and data error when connecting the clamp to the test board for EEPROM read/write:

- A. EEPROM read/write operations are affected by the circuit of the connected test board;
- B. EEPROM read/write operations of the test board are affected by the read/write operations of the clamp;
- C. The signal is damaged by large resistance. A large resistance will be generated when connecting the clamp to a fast communicating EEPROM or using a long cable for connection.

Therefore, it is recommended to dismantle the chip on the EEPROM, weld the EEPROM to the EEPROM adaptor or place in the EEPROM socket, and then insert it in the EEPROM adaptor.

18. EEPROM Clamp

19. DB15 VGA Port

EEPROM Adaptor

The EEPROM adaptor is compatible with three 8-pin packaging TSSOP, SOP, DIP connections, and each packaging reserves three same ports, so the device will function properly when one port is damaged. For SOP8 packaging, the EEPROM adaptor can also work with the EEPROM socket. To do this, place the pins of the SOP8 EEPROM into the EEPROM accordingly and then insert them into the EEPROM adaptor.

USB Port

The USB port is used for the data communication between the UP200 and the diagnostic device or the PC, and it is also the port for power supply charge.

EEPROM Read/Write Supported Types

Chip Type	Name	Chip Type	Name
ATMEL	AT24C01	ST	M24C04
ATMEL	AT24C02	ST	M24C08
ATMEL	AT24C04	ST	M24C16
ATMEL	AT24C08	ST	M24C32
ATMEL	AT24C16	ST	M24C64

Chip Type	Name	Chip Type	Name
ATMEL	AT24C32	FAIRCHILD	NM24C16U
ATMEL	AT24C64	FAIRCHILD	NM24C16UT
ATMEL	AT24C128	FAIRCHILD	NM24C17U
ATMEL	AT24C256	FAIRCHILD	NM24C17UT
ATMEL	AT24C512	MICROCHIP	85C72
ATMEL	AT24C1024	MICROCHIP	85C82
ATMEL	AT24C128_1.8	MICROCHIP	85C92
ATMEL	AT24C256_1.8	NXP	PCF8582C
ATMEL	AT24C512_1.8	NXP	PCF8594C
ATMEL	AT24C01A	NXP	PCF8598C
ST	ST24x01/ST25x01	ATMEL	AT25010
ST	ST24x02/ST25x02	ATMEL	AT25020
ST	ST24x04/ST25x04	ATMEL	AT25040
ST	ST24x08/ST25x08	ATMEL	AT25080
ST	ST24x16/ST25x16	ATMEL	AT25160
ST	M24C01	ATMEL	AT25320
ST	M24C02	ATMEL	AT25640
ATMEL	AT25128	MICROCHIP	25xx080
ATMEL	AT25256	MICROCHIP	25xx160
ATMEL	AT25512	MICROCHIP	25xx320
ATMEL	AT25010_1.8	MICROCHIP	25xx640
ATMEL	AT25020_1.8	MICROCHIP	25xx040_TSSOP
ATMEL	AT25040_1.8	MICROCHIP	25xx320_TSSOP
ATMEL	AT25080_1.8	MICROCHIP	25xx640_TSSOP

Chip Type	Name	Chip Type	Name
ATMEL	AT25160_1.8	CATALYST	CAT25C01
ATMEL	AT25320_1.8	CATALYST	CAT25C02
ATMEL	AT25640_1.8	CATALYST	CAT25C04
ATMEL	AT25128_1.8	CATALYST	CAT25C08
ATMEL	AT25256_1.8	CATALYST	CAT25C16
ST	M95010	CATALYST	CAT25C32
ST	M95020	CATALYST	CAT25C64
ST	M95040	CATALYST	CAT25C128
ST	M95080	CATALYST	CAT25C256
ST	M95160	ST	M35080
ST	M95320	XICOR	X5043
ST	M95640	XICOR	X5045
ST	M95128	XICOR	X25043
ST	M95256	XICOR	X25045
ST	M95512	MICROCHIP	93C06
MICROCHIP	25xx040	NATIONAL	NM93C13
NATIONAL	NM93C14	NATIONAL	NM93CS06
NATIONAL	NM93C14TM8	NATIONAL	NM93CS46
MICROCHIP	93C46X	NATIONAL	NM93CS56
MICROCHIP	93C46A	NATIONAL	NM93CS66
MICROCHIP	93C46	FAIRCHILD	FM93CS46T
MICROCHIP	93C46AX	ST	M93C46
MICROCHIP	93C46BX_93C46CX	ST	M93C56
MICROCHIP	93C56A	ST	M93C66

Chip Type	Name	Chip Type	Name
MICROCHIP	93C56	ST	M93C76
MICROCHIP	93C66A	ST	M93C86
MICROCHIP	93C66	ST	M93S46
MICROCHIP	93C76A	ST	M93S56
MICROCHIP	93C76	ST	M93S66
MICROCHIP	93C86A	ATMEL	AT59C11
MICROCHIP	93C86	ATMEL	AT59C22
ATMEL	AT93C46A	ATMEL	AT59C13
ATMEL	AT93C46	OKI	MSM16911
ATMEL	AT93C46R	TMC	TMC93LC46
ATMEL	AT93C56	TMC	TMC93LC56
ATMEL	AT93C57	TMC	TMC93LC57
ATMEL	AT93C66	TMC	TMC93LC66
ATMEL	AT93C76	TMC	TMC93LC86
ATMEL	AT93C86	SONY	CXK1011
SONY	CXK1012	Seiko	S_24S45
SONY	CXK1013	TOSHIBA	TC89101
Seiko	S_24H30	TOSHIBA	TC89102
Seiko	S_24H30_SOP8	TOSHIBA	TC89121
Seiko	S_24H45	TOSHIBA	TC89122
Seiko	S_24H45_SOP8	Xicor	X24C44
Seiko	S_24S30		

9S12 Read/Write Supported Types

Chip Type	Name
FREESCALE	MC9S12DG128

3 Getting Started

Ensure the tablet is sufficiently charged or is connected to the external power supply (see [Power Sources](#) on page 5).

NOTE

The images and illustrations depicted in this manual may differ from the actual ones.

Powering Up

Long press the Lock/Power button on the top right of the tablet to power on the unit. The power LED light will illuminate green. The system boots up, and displays the lock screen. Slide the Lock icon to the left to enter the OtoSys Job Menu or slide to the right to unlock.



Figure 3-1 Sample Job Menu

1. Application Buttons
2. Locator and Navigation Buttons
3. Status Icons

 **NOTE**







The tablet screen is locked by default when first powered on. It is recommended to lock the screen to protect the information in the system and reduce the power consumption.



The touch screen navigation is menu driven enabling quick access to functions and features by tapping on options headings and answering dialog windows. Detailed descriptions of the menu structures are found in the application chapters.

Application Buttons

Descriptions of the tool applications are displayed in the table below.

Table 3-1 Applications









Button	Name	Description
	IMMO	Accesses IMMO functions menu. See IMMO on page 23.
	Programming	Accesses Programming functions menu. See Programming on page 38.
	Diagnostics	Accesses diagnostic functions menu. See Diagnostics on page 42.
	Service	Accesses special functions menu. See Service on page 60.
	Update	Checks for the latest update available for the OtoSys system, and performs updates. See Update on page 86.
	Settings	Accesses OtoSys system settings menu and general tablet menu. See Settings on page 89.
	Remote Desk	Configures the unit to receive remote support using the TeamViewer application program. See Remote Desk on page 95.

Button	Name	Description
	Data Manager	Accesses the organization system for saved data files. See Data Manager Operations on page 97.
	Shop Manager	Accesses the Shop Manager program. See Shop Manager Operations on page 86.

Locator and Navigation Buttons

Operations of the Navigation buttons at the bottom of the screen are described in the table below:

Table 3-2 Locator and Navigation Buttons

Button	Name	Description
	Locator	Indicate the location of the screen. Swipe the screen left or right to view the previous or next screen.
	Back	Return to the previous screen.
	Android Home	Return to Android System's Home screen.
	Recent Apps	Display a list of applications that are currently in use. Tap an app icon to launch. To remove an app, swipe it to the top or bottom.
	Chrome	Launch the Android built-in browser.
	Screenshot	Take a screenshot when you want to save the displayed information.
	OtoSys Home	Return to OtoSys Job Menu.
	IMMO Shortcut	Return to the IMMO screen.
	Diagnostic Shortcut	Return to the Diagnostic screen.

Button	Name	Description
	Service Shortcut	Return to the Service screen.

System Status Icons





As the Display Tablet is working with the Android operating system, you may refer to Android documents for more information.

By up sliding the bottom right corner, a Shortcuts Panel will be displayed, on which you are allowed to set various system settings of the tablet. Operations of each button on the panel are described in the table below:

NOTE

The shortcuts buttons will be highlighted when enabled and dimmed when disabled.

Table 3-3 Shortcuts Panel Buttons

Button	Name	Description
	Calculator	Launches calculator when pressed.
	Clock	Launches clock when pressed.
	Wi-Fi	Enables/disables Wi-Fi when pressed.
	Airplane Mode	Enables/disables Airplane Mode when pressed.
	System Settings	Launches the Android System Settings screen when pressed.

Powering Down

All vehicle communications must be terminated before shutting down the Display Tablet. A warning message displays if you attempt to shut down the Display Tablet when it is communicating with the vehicle. Forcing a shut-down while communicating may lead to ECM problems on some vehicles. Please exit the Diagnostics application before powering down.

➤ **To power down the display tablet**

1. Long press the Lock/Power Button.
2. Tap **Power off** option.
3. Tap **OK**, the tablet will turn off in a few seconds.

Reboot System

In case of system crash, long press the Lock/Power button and tap **Reboot** option to reboot the system.

4 IMMO

The IMMO application provides Smart Mode and Expert Mode to guide technicians performing IMMO related functions, including Key Learning, Remote Control Learning, Remote Control Add, etc.

Getting Started

Ensure a communication link is established between the test vehicle and the tablet via the main cable, and the UP200 is connected to the tablet with the supplied USB cable.

Vehicle Menu Layout

When the tablet is properly connected to the vehicle, the platform is ready to start vehicle diagnosis. Tap on the **IMMO** application button on the OtoSys IM100 Job Menu to access the Vehicle Menu.











Figure 4-1 Sample Vehicle Menu

1. Top Toolbar Buttons
2. Manufacturer Buttons

Top Toolbar Buttons

The operations of the toolbar buttons at the top of the screen are listed and described in the table below:

Table 4-1 Top Toolbar Buttons

Button	Name	Description
	Home	Return to the OtoSys Job Menu.
	VIN Scan	Display a dropdown list; tap Auto Detect for auto VIN detection; tap Manual Input to enter VIN manually.
	All	Display all the vehicle makes in the vehicle menu.
	History	Display the stored test vehicle history records. This option provides you direct access to the previously tested vehicle recorded during previous test sessions. See Vehicle History on page 103.
	USA	Display the USA vehicle menu.
	Europe	Display the European vehicle menu.
	Asia	Display the Asian vehicle menu.
	Search	Display the virtual keyboard to manually enter the specific vehicle make required.
	Cancel	Exit the search screen or cancel an operation.

Manufacturer Buttons

To begin, select the manufacturer button of the test vehicle, followed by the vehicle model and year.

Vehicle Identification

The OtoSys diagnostic system supports four methods for Vehicle Identification.

1. Auto VIN Scan
2. Manual VIN Input
3. Automatic Selection
4. Manual Selection

Auto VIN Scan and Manual VIN Input functions are applicable for IMMO, Diagnostic and Service applications, Automatic Selection and Manual Selection are applicable for Diagnostic and Service applications. In IMMO, except Auto VIN Scan and Manual VIN Input methods, technicians can also manually select vehicle manufacturer, instrument information step by step to locate the desired IMMO part, but it is a little different from Automatic Selection and Manual Selection. Besides, as Programming does not require connection with the vehicle, therefore, Auto VIN Scan is not applicable for this application, and technicians can manually select the part information follow the onscreen instructions to display the function menu.

Auto VIN Scan

The OtoSys diagnostic system features the latest VIN-based Auto VIN Scan function to identify vehicles and it is applied to IMMO, Programming, Diagnostic and Service applications. IMMO provides two modes: Smart Mode and Expert Mode, and only Smart Mode can be accessed by using Auto VIN function.

➤ To perform Auto VIN Scan

1. Tap the **IMMO** application button from the OtoSys Job Menu. The Vehicle Menu displays.

2. Tap the **VIN Scan** button on the top toolbar to open a dropdown list.



Figure 4-2 Sample Auto VIN Screen

3. Select **Auto Detect**. Once the test vehicle is successfully identified, the screen will display the vehicle profile. Tap **OK** at the bottom right to confirm the vehicle profile. If the VIN does not match with the test vehicle's VIN, enter VIN manually or tap **Read** to acquire VIN again.
4. Tap **Yes** to confirm the vehicle profile or **NO** if the information is not correct.
5. The tool establishes communication with the vehicle and reads the IMMO control unit information.

Manual VIN Input

For vehicles that not supporting the Auto VIN Scan function, you may manually enter the vehicle VIN.

➤ To perform Manual VIN Input

1. Tap the **IMMO** application button from the OtoSys Job Menu. The Vehicle Menu displays.
2. Tap the **VIN Scan** button on the top toolbar.
3. Select **Manual Input**.

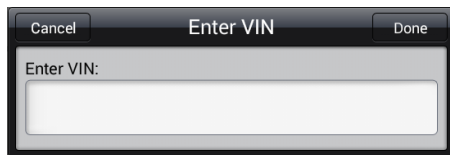

Figure 4-3 Sample Enter VIN Screen

4. Tap the input box and enter the correct VIN.
5. Tap **Done** to complete or tap **Cancel** to exit Manual Input.

Automatic Selection

The Auto VIN Scan can be selected after selecting the test vehicle manufacturer.

➤ To perform Automatic Selection

1. Tap the **Diagnostic** application button from the OtoSys Job Menu. The Vehicle Menu displays.
2. Tap the manufacturer button of the test vehicle.
3. Tap **Automatic Selection** and the VIN information will be automatically acquired. Follow the on-screen instruction to display the function screen.

Manual Selection

When the vehicle's VIN is not automatically retrievable through the vehicle's ECU, or the specific VIN is unknown, the vehicle can be manually selected.

This mode of vehicle selection is menu driven, repeat the first two steps from the automatic selection operation and tap **Manual Selection**. Through a series of on-screen prompts and selections, the test vehicle is chosen. If needed, press the **Back** button at the bottom right corner of the screen to return to the previous screen.

Navigation

Navigating the IMMO interface and selecting test are discussed in this section.

IMMO Screen Layout

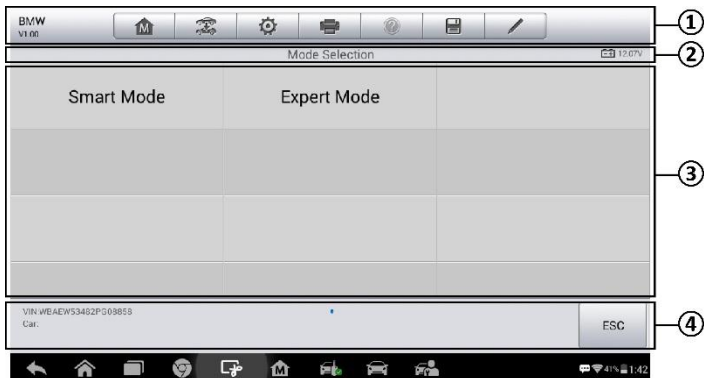

Figure 4-8 Sample Mode Selection Screen



The IMMO screens typically include four sections.





1. Operation Toolbar
2. Status Information Bar
3. Main Section
4. Functional Buttons

Operation Toolbar

The Operation Toolbar contains a number of buttons such as print and save. The table below provides a brief description of the operations.

Table 4-2 Operation Toolbar Buttons

Button	Name	Description
	Home	Return to the OtoSys Job Menu.
	Vehicle Swap	Exit the function session of the currently identified test vehicle and return to the vehicle menu screen.
	Settings	Open the settings screen. See Settings on page 89.

Button	Name	Description
	Print	Print a copy of the displayed data. See Printing Setting for additional information on page 90.
	Help	Display operational instructions or tips.
	Save	Tap to open a sub menu, tap Save This Page to take a screenshot. All saved data is stored in the Data Manager application for later reviews. See Data Manager Operations on page 97.
	Data Logging	Record the communication data and ECU information of the test vehicle. The saved data can be reported and sent to the technical center via the Internet. You can go to the Support application to follow up the processing progress, see Data Logging on page 101 for detailed information.

➤ **To print data**

1. Tap the **IMMO** application button from the OtoSys Job Menu. The **Print** button on the toolbar is available throughout the IMMO operations.
2. Tap **Print**. A drop-down menu displays. Tap **Print This Page** to print a screenshot of the current screen.
3. A temporary file will be created and send to the connected computer for printing.
4. When the file is transferred successfully, a confirmation message displays.

➤ **To submit Data Logging reports**

1. Tap the **IMMO** application button from the OtoSys Job Menu. The **Data Logging** button on the toolbar is available throughout the IMMO operations.
2. Tap the **Data Logging** button. The button displays blue during the active recording process.

3. Tap the **Data Logging** button again to end recording. A submission form will display for inputting of report information.
4. Tap the **Send** button to submit the report form via the Internet. A confirmation message displays when the report has been successfully sent.

Status Information Bar

The Status Information Bar at the top of the Main Section displays the following items:

1. Menu Title – displays the menu heading of the Main Section.
2. Voltage Icon – displays the vehicle's voltage status.

Main Section

The Main Section of the screen varies depending on the stage of operations. The Main Section can display vehicle identification selections, the main menu, test data, messages, instructions and other information. In this case, it shows the two modes IMMO provides: Smart Mode and Expert Mode.

Functional Buttons

The displayed Functional Buttons vary depending on the stage of operations. Functional buttons can be used to navigate menus, to save or clear data, to exit scanning and to perform a number of other control functions. The use of these buttons will be discussed in detail in the following sections of the corresponding test operations.

Screen Messages

Screen messages appear when additional input is needed before proceeding. There are three main types of on-screen messages: Confirmation, Warning, and Error.

Confirmation Messages

This type of messages usually displays as an "Information" screen to inform the user that a selected action cannot be reversed or when an action has been initiated and confirmation is needed to continue.

When a user-response is not required to continue, the message displays briefly.

Warning Messages

This type of messages displays a warning that a selected action may result in an irreversible change or loss of data. An example of this type of message is the “Erase Codes” message.

Error Messages

Error messages display when a system or procedural error has occurred. Examples of possible errors include a disconnection or communication interruption.

Making Selections

The IMMO application is a menu driven program that presents a series of choices. As a selection is made, the next menu in the series displays. Each selection narrows the focus and leads to the desired test. Tap the screen to make menu selections.

IMMO

The IMMO application requires a data link to the IMMO electronic control system of the test vehicle for diagnosis via OBD II connection. The application retrieves vehicle IMMO information and performs IMMO related functions, including Key Learning, Remote Control Learning, Remote Control Add, etc.

There are two options available when accessing the IMMO section:

1. Smart Mode – accesses to a function menu where each function is configured as a smart guide system.
2. Expert Mode – accesses to a function menu where each function is separated from each other.

After a mode is selected and the tablet establishes communication with the vehicle, the corresponding function menu or selection menu displays.

Smart Mode

The Smart Mode provides guided functions with step-by-step instructions. Once the test vehicle is identified, a vehicle profile will display, select **Yes** to continue.



Figure 4-4 Sample Vehicle Information Screen

The tablet will access the vehicle IMMO ECU to read IMMO related information. Press **OK** to continue. Then the vehicle key status will display.

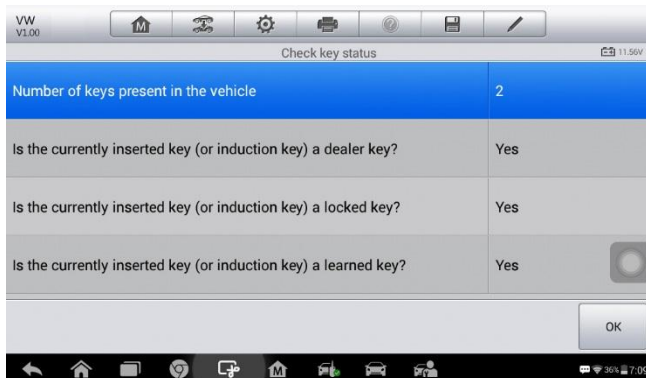

Figure 4-5 Sample Check Key Status Screen

Read the vehicle key status carefully and press **OK** to display the function menu.

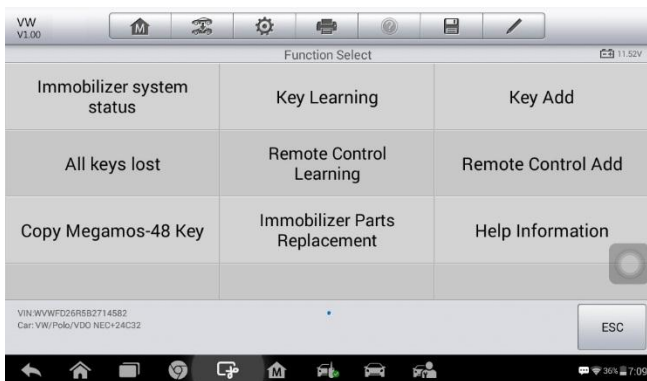

Figure 4-6 Sample Function Menu in Smart Mode

The functions vary by IMMO parts, please follow the onscreen instructions to select the correct IMMO part.

Take **Key Learning** as an example.

1. Select **Key Learning** from the function menu. The tablet will automatically start to read IMMO data.

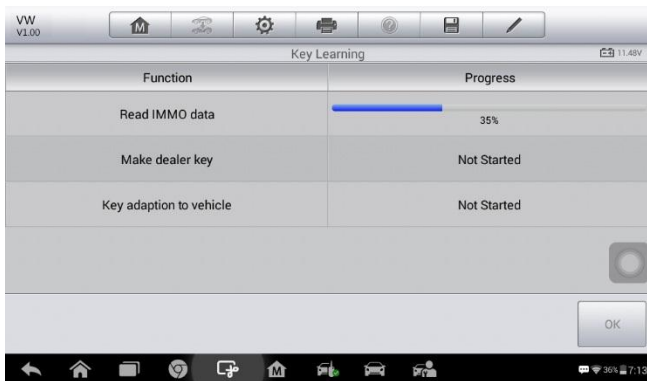

Figure 4-7 Sample Key Learning Screen 1

2. When Read IMMO data completes, the tablet will prompt a “Do you need to make dealer key?” message, select **Yes** to confirm, or select **NO** to quit the operation.



Figure 4-8 Sample Key Learning Screen 2

3. Follow the onscreen instruction to place a Blank Key in the UP200 keyhole and press **OK** to continue.

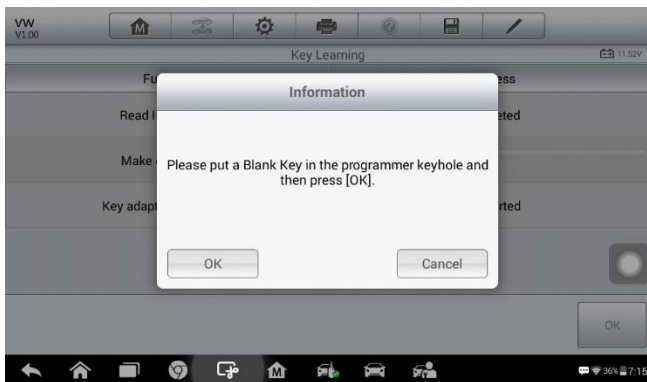

Figure 4-9 Sample Key Learning Screen 3

4. If the new key is blocked, the tablet will ask if you want to unlock the key, select **Yes** to continue, or select **NO** to quit the operation.
5. A "Make dealer key success!" message displays when the process is completed successfully.
6. Then the tablet will automatically move to the next step, Key adaption to vehicle, and the following message will prompt up.

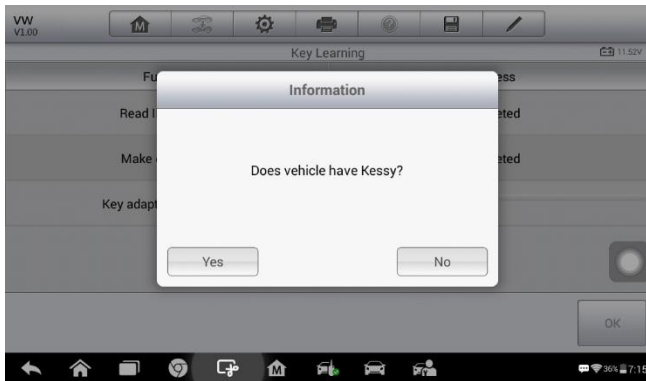

Figure 4-10 Sample Key Learning Screen 4

7. Make selections according to the test vehicle.
8. Input the numbers of the keys to be learned and press **OK** to continue.



Figure 4-11 Sample Key Learning Screen 5

9. Follow the onscreen instructions to insert the key to be learned into the vehicle ignition switch.

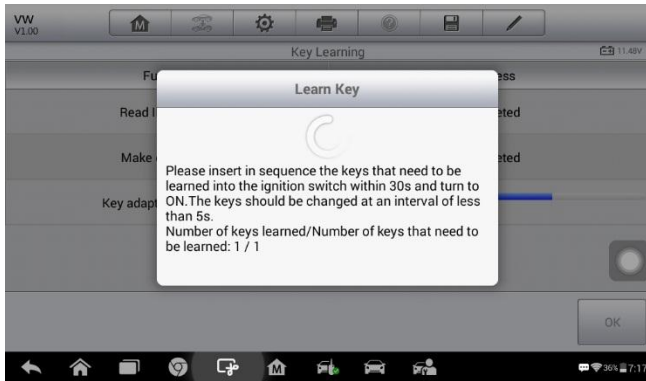

Figure 4-12 Sample Key Learning Screen 6

- When Key Learning is completed successfully, the following screen displays. Press **OK** to exit the function.

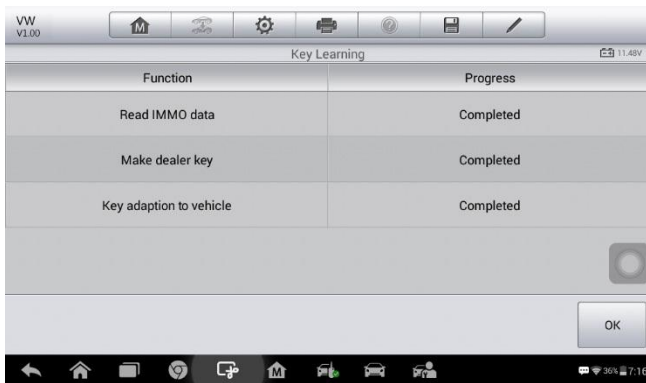

Figure 4-13 Sample Key Learning Screen 7

Expert Mode

Expert Mode provides skilled technicians a convenient way to perform individual IMMO functions they need. All the function options in this mode are separated segments. If needed, technicians can only perform one segment function instead of a whole process provided in Smart Mode.

- Select vehicle manufacturer in the vehicle menu, and then select the

IMMO part information step by step to locate the IMMO part and display the function menu.

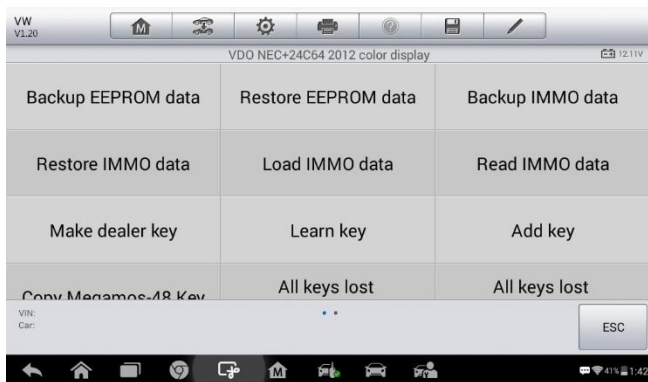

Figure 4-14 Sample Expert Mode Function Menu

Take **Read IMMO Data** as an example.

Select **Read IMMO Data** from the function menu. The tablet will start to read IMMO information. Review the data and press **OK** to exit.



Figure 4-15 Sample Read IMMO Data Screen

After read the IMMO data, technicians can perform other IMMO functions with the read data in Expert Mode.

5 Programming

The Programming application requires connection between the tablet and the UP200, and no vehicle connection is required. This application can access the key chip, read, retrieve and write key information, as well as other key related functions.

Programming

Select the vehicle manufacturer in the vehicle menu, and then follow the onscreen instructions to select the instrument information to display the function menu.

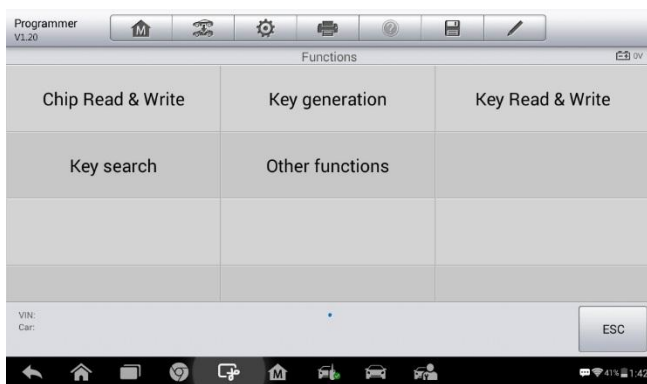

Figure 5-1 Sample Programming Function Menu

Take **Chip Read & Write** as an example.

1. Select **Chip Read & Write** from the menu.
2. Select the chip type if needed. In this example, select EEPROM.

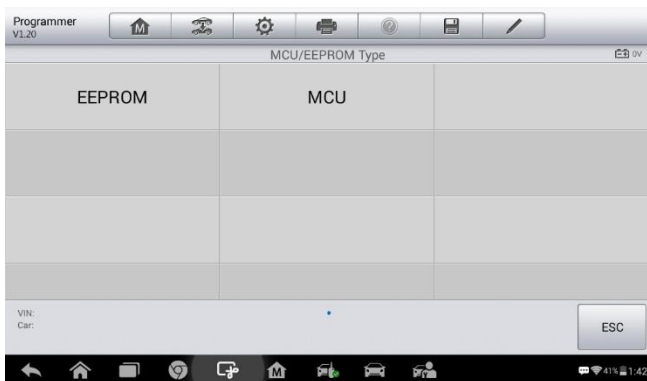

Figure 5-2 Sample Select Chip Type Screen

3. Select **Read Operation** on the next menu.

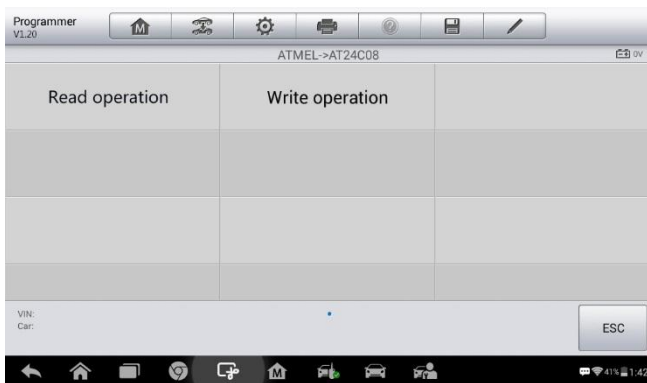

Figure 5-3 Sample Operations Menu

4. The chip data screen displays. Select **Save** to save the data, or select **Cancel** to exit.

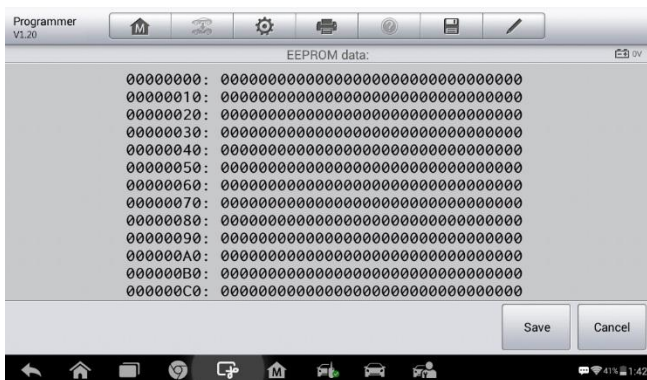

Figure 5-4 Sample Read Operation Screen

5. Type the file name and select Confirm, the chip data will be saved on the tablet. And a “File saved successfully.” Message displays.

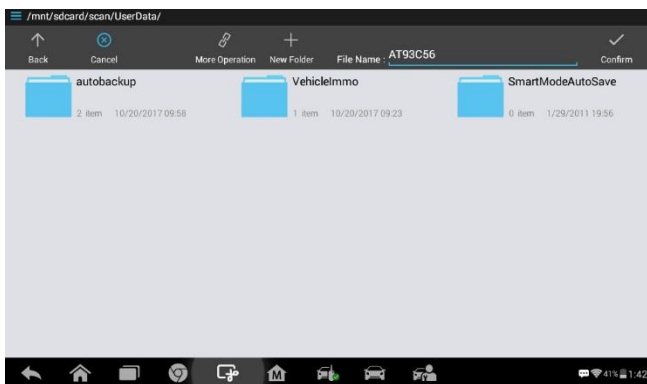

Figure 5-5 Sample Save Data Screen

6. Select **Write Operation** from the operations menu. The tablet will open the default folder, select the saved data and click **Confirm** to write it into a black chip.

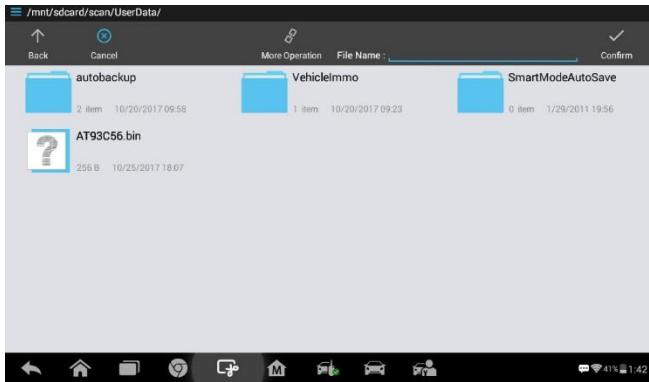

Figure 5-6 Sample Write Operation Screen

6 Diagnostics

The Diagnostics application can retrieve ECU information, read & erase DTCs, and view live data. The Diagnostics application can access the electronic control unit (ECU) for various vehicle control systems, including engine, transmission, antilock brake system (ABS), airbag system (SRS).

Diagnosis

The Diagnostics application enables a data link to the electronic control system of the test vehicle for vehicle diagnosis via OBD II connection. The application performs functional tests, retrieves vehicle diagnostic information such as trouble and event codes and live data for various vehicle control systems, such as engine, transmission, and ABS.

There are two options available when accessing the Diagnosis section:

1. Auto Scan – starts auto scanning for all the available systems on the vehicle.
2. Control Units – displays a selection menu of all available control units of the test vehicle.

After a section is made and the tablet establishes communication with the vehicle, the corresponding function menu or selection menu displays.

Auto Scan

The Auto Scan function performs a comprehensive scanning over all the ECUs in the vehicle to locate systems' faults and retrieve DTCs. An example of the Auto Scan interface is pictured below:

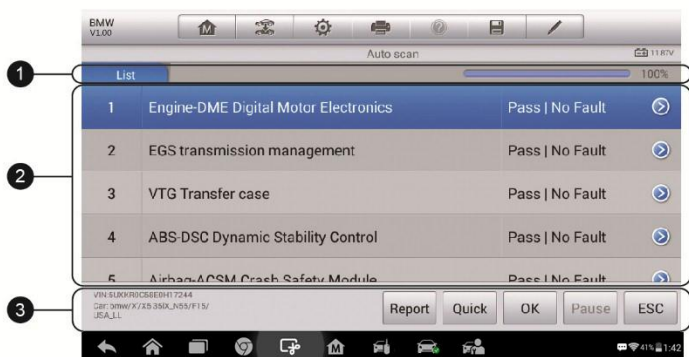

Figure 6-1 Sample Auto Scan Operation Screen

1. Navigation Bar
2. Main Section
3. Functional Buttons

Navigation Bar

List Tab – displays the scanned data in list format.

Progress Bar – indicates the test progress.

Main Section

Column 1 – displays the sequence numbers.

Column 2 – displays the scanned systems.

Column 3 – displays the diagnostic indicators describing test results.

These indicators are defined as follows:

- ❖ **-!-**: Indicates that the scanned system may not support the code reading function, or there is a communication error between the Display Tablet and the control system.
- ❖ **-?-**: Indicates that the vehicle control system has been detected, but the Display Tablet cannot accurately locate it.

- ✧ **Fault(s) | #:** Fault(s) indicates there is/are detected fault code(s) present; “#” indicates the number of the detected faults.
- ✧ **Pass | No Fault:** Indicates the system has passed the scanning process and no fault has been detected.

Column 4 – to perform further diagnosis or testing on a specific system item, tap the  button to the right of that item. A Function Menu screen will display.

Functional Buttons

A brief description of the operations of the Auto Scan's Functional Buttons' are displayed in the table below.

Table 6-1 Functional Buttons in Auto Scan

Name	Description
Report	Display the diagnostic data in the report form.
Quick Erase	Delete codes. A warning message screen will display to inform you of possible data loss when this function is selected.
OK	Confirm the test result. Continue to the system diagnosis after the required system is selected by tapping the item in the Main Section.
Pause	Suspend scanning and it will change to Continue button after tapping.
ESC	Return to the previous screen or exits Auto Scan.

Control Units

Manually locate a required control system for testing through a series of selection choices. Follow the menu driven procedures and make proper selection; the application guides the user to the proper diagnostic function menu based on selections.

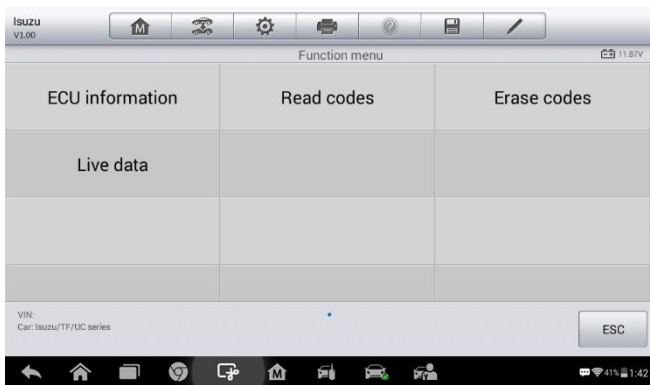

Figure 6-2 Sample Function Menu

The Function Menu options vary slightly for different vehicles. The function menu may include:

- **ECU Information** – provides the retrieved ECU information in detail. An information screen opens upon selection.
- **Read Codes** – displays detailed information of DTC records retrieved from the test vehicle's ECU.
- **Erase Codes** – erases DTC records and other data from the test vehicle's ECU.
- **Live Data** – retrieves and displays live data and parameters from the test vehicle's ECU.

NOTE

Toolbar functions such as saving and printing of test results can be performed throughout diagnostic testing. Data logging and access to help information are also available.

➤ **To perform a diagnostic function**

1. Establish communication with the test vehicle.
2. Identify the test vehicle by selecting from the menu options.
3. Select the **Diagnosis** section.
4. Locate the required system for testing by **Auto Scan** or through menu driven selections in **Control Units**.
5. Select the desired diagnostic function from the **Function Menu**.

ECU Information

This function retrieves and displays the specific information for the tested control unit, including unit type, version numbers and other specifications.

The sample ECU Information screen displays as below:

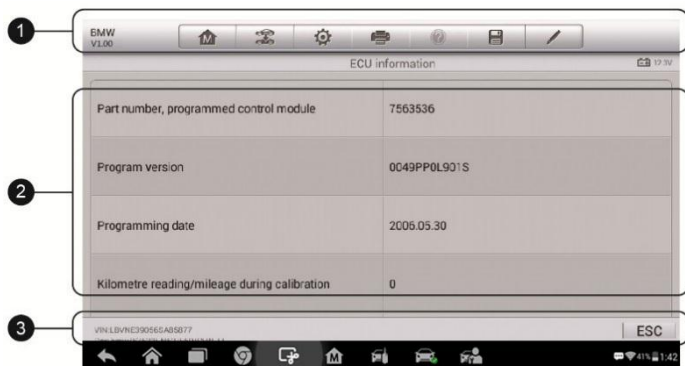

Figure 6-3 Sample ECU Information Screen

1. Diagnostics Toolbar Buttons – see [Table 4-2 Operation Toolbar Buttons](#) on page 28 for detailed descriptions of the operations for each button.
2. Main Section – the left column displays the item names; the right column displays the specifications or descriptions.
3. Functional Button – **ESC** (or **Back**) button is available; tap it to exit after viewing.

Read Codes

This function retrieves and displays the DTCs from the vehicle's control system. The Read Codes screen varies for each vehicle being tested. On some vehicles, freeze frame data can also be retrieved for viewing. The sample Read Codes screen displays as below:

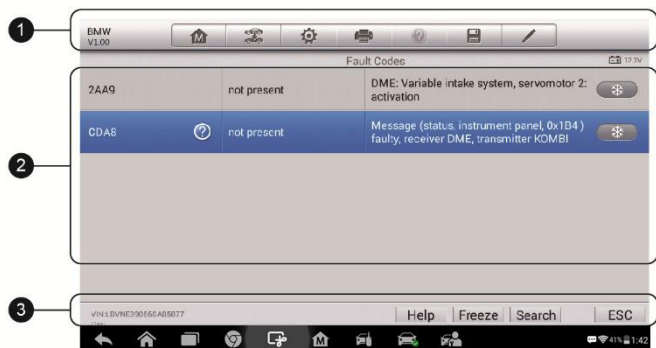

Figure 6-4 Sample Read Codes Screen

1. Diagnostics Toolbar Buttons – see [Table 4-2 Operation Toolbar Buttons](#) on page 28 for detailed descriptions of the operations for each button.
2. Main Section
 - Code Column – displays the retrieved codes from the vehicle.
 - Status Column – indicates the status of the retrieved codes.
 - Description Column – detailed descriptions for the retrieved codes.
 - Snowflake Icon – only displays when freeze frame data is available for viewing; selecting this icon will display a data screen, which looks and behaves similar to the Read Codes screen.
3. Functional Button
 - Help – tap it to view fault code information, including fault description, condition for fault identification, and driver information.
 - Freeze frame – tap it to view the freeze frame data of the selected DTC.
 - Search – tap it to search related fault code information on Google.
 - ESC – tap it to return to the previous screen or exit the function.

Erase Codes

After reading the retrieved codes and making appropriate vehicle repairs, use this function to erase vehicle codes.

- **To erase codes**

1. Tap **Erase Codes** from the Function Menu.
2. A warning message displays to advice of data loss if this function is completed.
 - a) Tap **Yes** to continue. A confirming screen displays when the operation is successfully done.
 - b) Tap **No** to exit.
3. Tap **ESC** on the confirming screen to exit Erase Codes.
4. Perform the Read Codes function again to check if codes have been erased successfully.

Live Data

When this function is selected, the screen displays the data list for the selected module. The data available for any control module varies from one vehicle to another. The parameters display in the order that they are transmitted by the ECM, so expect variation among vehicles.

Gesture scrolling allows for quick movement through the data list. Touch the screen and drag your finger up or down to reposition the parameters being displayed if the data populates more than one screen. The figure below displays a typical Live Data screen.

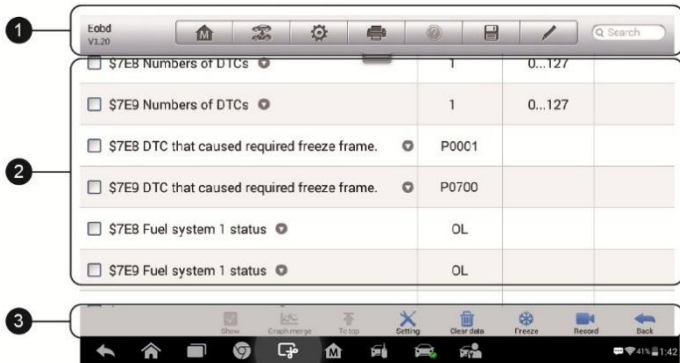

Figure 6-5 Sample Live Data Screen

1. Diagnostics Toolbar Buttons – tap the drop-down button at the top center of the screen and the toolbar buttons will display. See [Table 4-2 Operation Toolbar Buttons](#) on page 28 for detailed descriptions of the

operations for each button.

2. Main Section

- Name Column – displays the parameter names.
 - a) Check Box – tap the check box on the left side of the parameter name to make item selection. Tap the check box again to deselect the item.
 - b) Drop-down Button – tap the drop-down button at the right side of the parameter name to open a sub menu, which provides optional modes by which to display the data.
- Value Column – displays the values of the parameter items.
- Unit Column – displays the unit for the parameters.
 - To change the unit mode, tap the **Setting** button on the top toolbar and select a required mode. See *Unit* on page 89 for more information.

Display Mode

There are four types of display modes available for data viewing. Select the proper mode for the diagnostic purpose.

Tap the drop-down button on the right side of the parameter name to open a sub menu. There are four buttons to configure the data display mode, and a Help button for access to additional information.

Each parameter item displays the selected mode independently.

- 1) Analog Gauge Mode – displays the parameters in form of an analog meter graph.
- 2) Text Mode – this is the default mode which displays the parameters in texts and shows in list format.

NOTE

Status parameters, such as a switch reading, can primarily be viewed in text form such as ON, OFF, ACTIVE, and ABORT. Whereas, value parameters, such as a sensor reading, can be displayed in text mode and graph modes.

- 3) Waveform Graph Mode – displays the parameters in waveform graphs.

When this mode is selected, three control buttons display on the right side of the parameter item for manipulation of display status.

- Text Button – resumes Text Display Mode.
- Scale Button – changes the scale values that are displayed below the waveform graph. There are four scales available: x1, x2, x4 and x8.
- Zoom-in Button – tap once to display the selected data graph in full screen.
 - ✧ Edit Button – tap to open an edit window, on which you can set the waveform color and the line thickness displayed for the selected parameter item.
 - ✧ Scale Button – tap to change the scale values, which are displayed below the waveform graph. There are four scales available: x1, x2, x4 and x8.
 - ✧ Zoom-out Button – tap to exit full screen display.
- 4) Digital Gauge Mode – displays the parameters in form of a digital gauge graph.

Full Screen Display – this option is only available in the waveform graph mode, and primarily used in Graph Merge status for data comparison. Under this mode, there are three control buttons available on the top right side of the screen.

➤ **To edit the waveform color and line thickness in a data graph**

1. Select 1 to 3 parameter items to display in Waveform Graph mode.
 2. Tap the **Zoom-in Button** on the right to display the data graph in full screen.
 3. Select a parameter item on the left column.
 4. Select a desired sample color from the middle column.
 5. Select a desired sample line thickness from the right column.
 6. Repeat steps 3-5 to edit the waveform for each parameter item.
 7. Tap **Done** to save the setting and exit, or tap **Cancel** to exit without saving.
3. Functional Buttons

The operations of available functional buttons on the Live Data screen are described below:

Back – returns to previous screen or exits the function.

Record – starts recording the retrieved live data; the recorded data is then stored as a video clip in the Data Manager application for future reviews. This function can be triggered automatically at preset threshold value or values may be set manually. The triggering mode and record duration can be configured in the Setting mode of Live Data.

Freeze frame – displays the retrieved data in freeze frame mode.

- Previous Frame – displays previous frame if the freeze frame data.
- Next Frame – advances to the next frame in the freeze frame data.

Clear Data – tap button to clear all previously retrieved parameter values at a particular cutting point.

To Top – moves a selected data item to the top of the list.

Graph Merge – tap button to merge selected data graphs (for Waveform Graph Mode only). This function is useful for comparisons between different parameters.

 **NOTE**

In this mode, Graph Merge can only display up to three parameter items.

- To cancel Graph Merge mode, tap the drop-down button on the right side of the parameter name, and select a data display mode.

Show – tap button to switch between the two options; one displays the selected parameter items, the other displays all the available items.

Setting – tap button to access setting screen to set the trigger mode, recording duration and threshold values for data recording, and define other control settings.

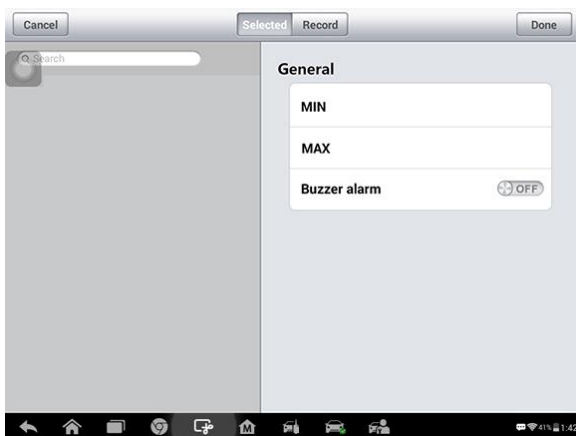

Figure 6-6 Sample Setting Mode in Live Data

There are four navigation buttons on top of the **Setting** mode screen.

- **Selected Button** – displays the configuration screen on which you can set the threshold values, an upper limit and a lower limit, for triggering the buzzer alarm. This function is only applied to the Waveform Graph display mode.
 - a) **MIN** – tap button to open a virtual keyboard, allowing you to enter the required lower limit value.
 - b) **MAX** – tap button to open a virtual keyboard, allowing you to enter the required upper limit value.
 - c) **Buzzer Alarm** – switches the alarm on and off.
- **To set threshold limits for the parameter values**
 1. Tap the **Setting** functional button at the bottom of the Live Data screen.
 2. Tap the **Selected** navigation button.
 3. Select a parameter item on the left column, or enter the item name in the Search bar.
 4. Tap on the right side of the **MIN** button, and enter the required minimum value.
 5. Tap on the right side of the **MAX** button, and enter the required



maximum value.

6. Tap the **ON/OFF** button on the right side of the Buzzer Alarm button to turn it on or off.
7. Tap **Done** to save the setting and return to the Live Data screen; or tap **Cancel** to exit without saving.

If the threshold limits are successfully set, two horizontal lines will appear on each of the data graphs (when Waveform Graph Mode is applied) to indicate the alarming point. The threshold lines are shown in different colors from the waveform of the parameters for distinction.

- **Record Button** – displays the configuration screen for Record Setting, on which you can set the trigger type, duration and trigger point for the data recording function.
 - a) **Trigger Type** – sets the trigger mode for data recording, mainly of two kinds: Manual and Auto. There are four options available:
 - 1) **Manual** – allows you to manually start and stop data recording
 - 2) **DTC** – auto triggers data recording when any DTC is detected
 - 3) **DTC Check Mode** – auto triggers data recording when certain pre-selected DTC types are detected
 - 4) **Parameter** – auto triggers data recording when any parameter value reaches the preset threshold
 - b) **Duration** – sets the recording time (for Auto trigger mode only)
 - c) **Trigger Point** – reserves a relative percentage of a record length before the data recording start point for reference (for Auto trigger mode only)

➤ **To perform setting for live data record**

1. Tap the **Setting** functional button at the bottom of the Live Data screen.
2. Tap the **Record** navigation button.
3. Tap the  button on the right of **Trigger Type** bar and select the required trigger mode.
4. Tap the  button on the right of **Duration** bar and select a length of time.
5. Tap the  button on the right of **Trigger Point** bar and select a

relative percentage of a record length to be reserved before the data recording start point.

6. Tap **Done** to save the setting and return to the Live Data screen; or tap **Cancel** to cancel without saving and exit Setting.
- **Done Button** – confirms and saves the setting, and returns to the Live Data screen.
 - **Cancel Button** – cancels the setting operation, and returns to the Live Data screen.

Generic OBD II Operations

A fast-access option for OBD II/EODB vehicle diagnosis is available on the Vehicle Menu screen. This option presents a quick way to check for DTCs, isolate the cause of an illuminated malfunction indicator lamp (MIL), check monitor status prior to emissions certification testing, verify repairs, and perform a number of other services that are emissions-related. The OBD direct access option is also used for testing OBD II/EODB compliant vehicles that are not included in the Diagnostics database.

Functions of the diagnostics toolbar buttons at the top of the screen are the same as those available for specific vehicle diagnostics. See [Table 4-2 Operation Toolbar Buttons](#) on page 28 for details.

General Procedure

➤ To access the OBD II/EODB diagnostics functions

1. Tap the **Diagnostics** application button from the OtoSys Job Menu. The Vehicle Menu displays.
2. Tap the **EOBD** button. There are two options to establish communication with the vehicle.
 - **Auto Scan** – when this option is selected the diagnostic tool attempts to establish communication using each protocol in order to determine which one the vehicle is broadcasting on.
 - **Protocol** – when this option is selected the screen opens a submenu of various protocols. A communication protocol is a standardized way of data communication between an ECM and a diagnostic tool. Global OBD may use several different

communication protocols.

3. Select a specific protocol under the **Protocol** option. Wait for the OBD II Diagnostic Menu to appear.



NOTE

Tap the  button beside the function name to display additional information.

4. Select a function option to continue.

- **DTC & FFD**
- **I/M Readiness**
- **Live Data**
- **On-Board Monitor**
- **Component Test**
- **Vehicle Information**
- **Vehicle Status**



NOTE

Some functions are supported only on certain vehicles.

Function Descriptions

This section describes the various functions of each diagnostic option:

DTC & FFD

When this function is selected, the screen displays a list of Stored Codes and Pending Codes. When the Freeze Frame data of certain DTCs are available for viewing, a snowflake button will display on the right side of the DTC item.



Figure 6-7 Sample DTC & FFD Screen

The erase codes function can be applied by tapping the **Clear DTC** button at the bottom of the screen.

- **Stored Codes**

Stored codes are the current emission related DTCs from the ECM of the vehicle. OBD II/EOBD Codes have a priority according to their emission severity, with higher priority codes overwriting lower priority codes. The priority of the code determines the illumination of the Malfunction Indicator Light (MIL) and the codes erase procedure. Manufacturers rank codes differently, so expect to see differences between vehicles.

- **Pending Codes**

These are codes whose setting conditions were met during the last drive cycle, but need to be met on two or more consecutive drive cycles before the DTC actually sets. The intended use of this service is to assist the service technician after a vehicle repair and after clearing diagnostic information, by reporting test results after a driving cycle.

- If a test failed during the driving cycle, the DTC associated with that test is reported. If the pending fault does not occur again within 40 to 80 warm-up cycles, the fault is automatically cleared from memory.
- Test results reported by this service do not necessarily indicate a faulty component or system. If test results indicate another failure after additional driving, then a DTC is set to indicate a faulty component or system, and the MIL is illuminated.

- **Freeze Frame**

In most cases the stored frame is the last DTC that occurred. Certain DTCs, which have a greater impact on vehicle emission, have a higher priority. In these cases, the top prioritized DTC is the one for which the freeze frame records are retained. Freeze frame data includes a “snapshot” of critical parameter values at the time the DTC is set.

- **Clear DTC**

This option is used to clear all emission related diagnostic data such as, DTCs, freeze frame data and manufacturer specific enhanced data from the vehicle’s ECM.

A confirmation screen displays when the clear codes option is selected to prevent accidental loss of data. Select **Yes** on the confirmation screen to continue or **No** to exit.

I/M Readiness

This function is used to check the readiness of the monitoring system. It is an excellent function to use prior to having a vehicle inspected for compliance to a state emissions program. Selecting I/M Readiness opens a submenu with two choices:

- **Since DTCs Cleared** – displays the status of monitors since the last time the DTCs are erased.
- **This Driving Cycle** – displays the status of monitors since the beginning of the current drive cycle.

Live Data

This function displays the real time PID data from ECU. Displayed data includes analog inputs and outputs, digital inputs and outputs, and system status information broadcast on the vehicle data stream.

Live data can be displayed in various modes, see [Live Data](#) on page 48 for detailed information.

O2 Sensor Monitor

This option allows retrieval and viewing of O2 sensor monitor test results for the most recently performed tests from the vehicle’s on-board computer.

The O2 Sensor Monitor test function is not supported by vehicles that communicate using a controller area network (CAN). For O2 Sensor Monitor tests results of CAN-equipped vehicles, refer to *On-Board Monitor*.

On-Board Monitor

This option allows you to view the results of On-Board Monitor tests. The tests are useful after servicing or after erasing a vehicle's control module memory.

Component Test

This service enables bi-directional control of the ECM so that the diagnostic tool is able to transmit control commands to operate the vehicle systems. This function is useful in determining whether the ECM responds to a command well.

Vehicle Information

The option displays the vehicle identification number (VIN), the calibration identification, and the calibration verification number (CVN), and other information of the test vehicle.

Vehicle Status

This item is used to check the current condition of the vehicle, including communication protocols of OBD II modules, retrieved codes amount, status of the Malfunction Indicator Light (MIL), and other additional information.

Exiting Diagnostics

The Diagnostics application remains open as long as there is an active communication with the vehicle. You must exit the diagnostics operation to stop all communications with the vehicle before closing the Diagnostics application.

NOTE

Damage to the vehicle electronic control module (ECM) may occur if communication is disrupted. Make sure all connections, such as USB cable and wireless connection, are properly connected at all times during testing. Exit all tests before disconnecting the test connection or powering down the tool.

➤ **To exit the Diagnostics application**

1. From an active diagnostic screen, tap the **Back** or **ESC** functional button to exit a diagnostic session step-by-step.
2. Or tap the **Vehicle Swap** button on the diagnostics toolbar to return to the Vehicle Menu screen.
3. From the Vehicle Menu screen, tap the **Home** button on the top toolbar; or tap the **Back** button on the navigation bar at the bottom of the screen.
4. Or tap the **Home** button on the diagnostics toolbar to exit the application directly and go back to the OtoSys Job Menu.

Now, the Diagnostics application is no longer communicating with the vehicle and it is safe to open other OtoSys applications, or exit the OtoSys Diagnostic System and return to the Android System's Home screen.

7 Service

The Service section is specially designed to provide you with quick access to the vehicle systems for various scheduled service and maintenance performances. The typical service operation screen is a series of menu driven executive commands. By following the on-screen instructions to select appropriate execution options, enter correct values or data, and perform necessary actions, the system will guide you through the complete performance for various service operations.

The most commonly performed service functions include:

- Oil Reset Service
- EPB Service
- BMS Service
- SAS Service
- DPF Service
- TPMS Service

After entering each special function, the displayed screen consists of two applications: **Diagnosis** and **Hot Functions**. The **Diagnosis** is for you to read/clear data since this is necessary after some special functions. **Hot Functions** consists of sub functions of the selected special function.

Oil Reset Service

This function allows you to perform reset for the Engine Oil Life system, which calculates an optimal oil life change interval depending on the vehicle driving conditions and climate. The Oil Life Reminder must be reset every time the oil is changed, so the system can calculate when the next oil change is required.

! IMPORTANT

Always reset the engine oil life to 100% after every oil change.

NOTE

1. All required work must be carried out before the service indicators are reset. Failure to do so may result in incorrect service values and cause DTCs to be stored by the relevant control module.
2. For some vehicles, the scan tool can perform added functionality to reset additional service lights (maintenance cycle, service interval). Taking BMW as an example, its service reset function includes engine oil, spark plugs, front/rear brakes, coolant, particle filter, brake fluid, micro filter, vehicle inspection, exhaust emission inspection and vehicle check.

All software screens shown in this manual are examples, actual test screens may vary for each vehicle being tested. Observe the menu titles and on-screen instructions to make correct option selections.

➤ To perform oil reset functions

1. Tap the **Service** application button from the OtoSys Job Menu.
2. Tap **Oil Reset** button and wait for the vehicle manufacturer screen. You can tap **VIN Scan** or the vehicle make to acquire vehicle VIN information and tap **Yes** to confirm. See [Vehicle Identification](#) on page 24 for details.
3. Tap the function you want in the Oil Reset function list, the list may vary for different vehicles being tested.

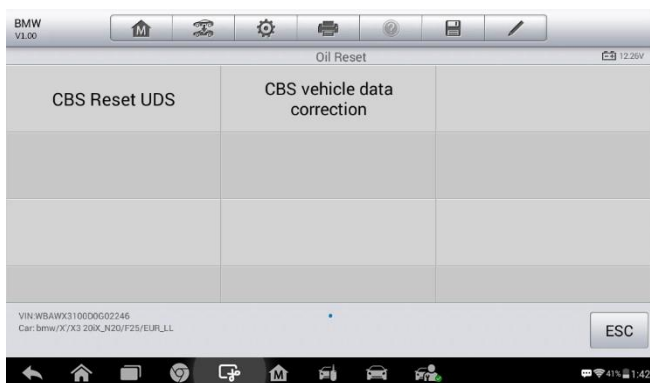

Figure 7-1 Sample Oil Reset Function List

4. Follow the step-by-step on-screen instruction to complete the service. Take CBS Reset UDS as an example.

5. Tap **CBS Reset UDS** on the Oil Reset function list to start the operation. The screen will guide you to confirm the date and time, if the displayed date and time are correct, tap **Yes** to confirm. If not, tap **No** and go to the Settings menu to set the correct date and time.

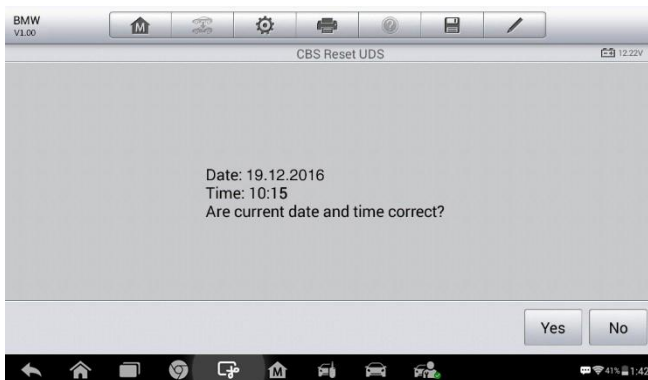

Figure 7-2 Sample Oil Reset Service Screen 1

6. On the next screen, the available items would be listed with three columns displayed: CBS value, availability, and service counter.

CBS value	availability	service counter
Engine oil	32 %	5
Front Brake	97 %	9
Rear Brake	96 %	6

Figure 7-3 Sample Oil Reset Service Screen 2

7. Tap on the value you want to reset and then tap the **Reset** button on the right bottom of the screen.
8. When the reset is done, the availability would display as 100%. Tap **ESC** to exit.

Electronic Parking Brake (EPB) Service

This function has a multitude of usages to maintain the electronic braking system safely and effectively. The applications include deactivating and activating the brake control system, assisting with brake fluid control, opening and closing brake pads, and setting brakes after disc or pad replacement, etc.

EPB Safety

It may be dangerous to perform Electronic Parking Brake (EPB) system maintenance, so before you begin the service work, please keep these rules in mind.

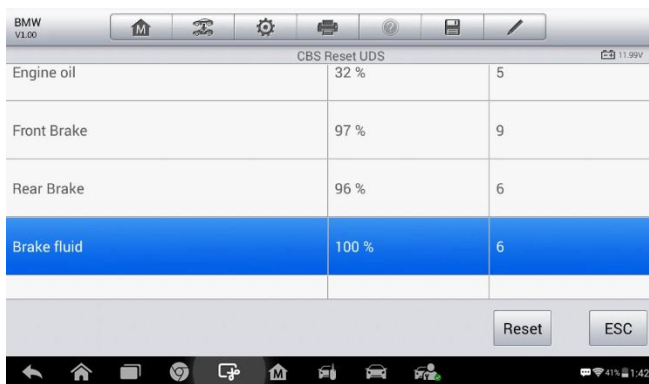

CBS Reset UDS		
Engine oil	32 %	5
Front Brake	97 %	9
Rear Brake	96 %	6
Brake fluid	100 %	6

Figure 7-4 Sample Oil Reset Service Screen 3

- ✓ Ensure that you are fully familiar with the braking system and its operation before commencing any work.
- ✓ The EPB control system may be required to be deactivated before carrying out any maintenance/diagnostic work on the brake system. This can be done from the tool menu.
- ✓ Only carry out maintenance work when the vehicle is stationary and on level ground.
- ✓ Ensure that the EPB control system is reactivated after the maintenance work has been completed.

NOTE

Auro accepts no responsibility for any accident or injury arising from the maintenance of the Electronic Parking Brake system.

➤ To perform EPB functions

1. Tap the **Service** application button from the OtoSys Job Menu.
2. Tap **EPB** button and wait for the vehicle manufacturer screen. You can tap **VIN Scan** or the vehicle make to acquire vehicle VIN information and tap **Yes** to confirm. See [Vehicle Identification](#) on page 24 for details.
3. Tap the service you want in the EPB function list, the list may vary for different vehicles being tested.

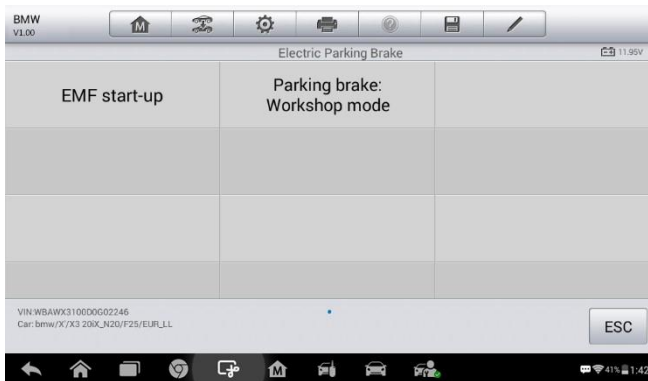

Figure 7-5 Sample EPB Function List

4. Follow the step-by-step on-screen instruction to complete the service.
5. Press **OK** button to exit.

EMF Start-up

This service function would start up the parking brake, it must be conducted after the following repairs:

- Replacing an EMF control unit.

- Replacing the parking brake button.

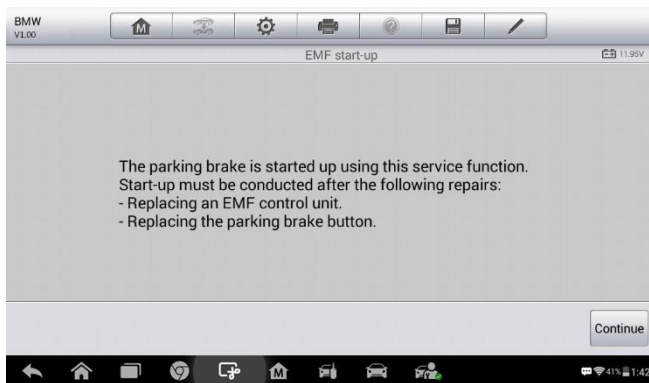

Figure 7-6 Sample EMF Start-up Screen 1

- 1) Tap **Continue** to proceed this service function or the **Back** button at the bottom left to exit.
- 2) Tap on the action that has been carried out to continue.

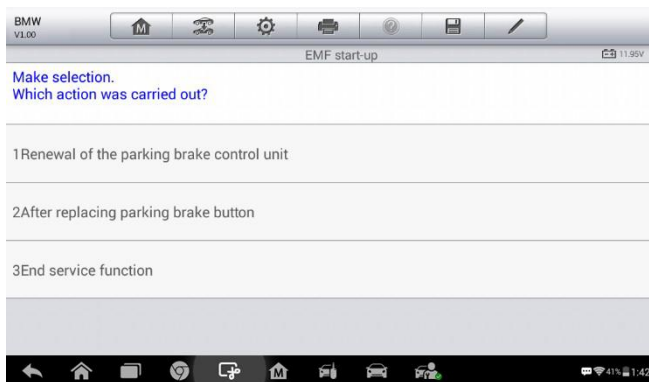

Figure 7-7 Sample EMF Start-up Screen 2

- 3) In the following step, the screen will remind you that the fault memory of the parking brake control unit will be deleted, press **Continue** to proceed or the **Back** button to exit.

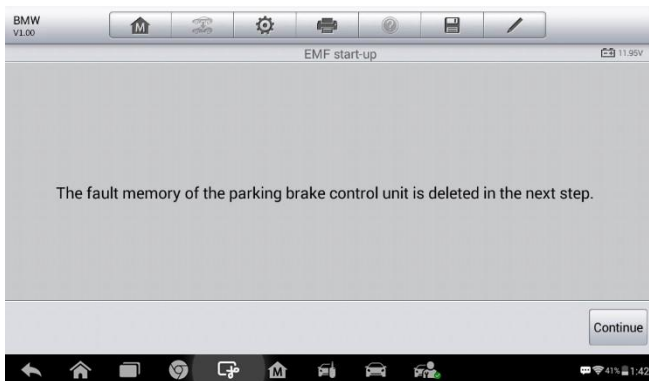

Figure 7-8 Sample EMF Start-up Screen 3

- 4) Follow the on-screen instructions to pull the parking brake button and wait for around 3 seconds until the parking brake is set. When the operation is successfully completed, a “Completed successfully” message will appear on the screen. Press “OK” to exit.

Parking Brake: Workshop Mode

This service is used to activate and deactivate the so-called installation position for the Automatic Hold brake. In this mode the parking brake is moved into the opened position and temporarily deactivated for personal protection.

The installation position must be activated for the following repairs:

- Replacement of brake pads.
- Replacement of a brake caliper.
- Replacement of an actuator.

Select **Parking Brake: Workshop Mode** and follow the on-screen instructions to perform a series of operations to start the brake pad after replacement.

When the operation is successfully completed, a “Completed successfully” message will appear on the screen. Press **OK** to exit.

BMS

The BMS (Battery Management System) allows the scan tool to evaluate the battery charge state, monitor the close-circuit current, register the battery replacement, and activate the rest state of the vehicle.

NOTE

1. This function is not supported by all vehicles. The screens shown in this section are examples.
2. The sub functions and actual test screens of the BMS may vary for different test vehicles, please follow the on-screen instructions to make correct option selection.

The vehicle may use either a sealed lead-acid battery or an AGM (Absorbed Glass Mat) battery. Lead acid battery contains liquid sulphuric acid and can spill when overturned. AGM battery (known as VRLA battery, valve regulated lead acid) also contains sulphuric acid, but the acid is contained in glass mats between terminal plates.

It is recommended that the replacement aftermarket battery has the same specifications, such as capacity and type, with the battery used in the vehicle. If the original battery is replaced with a different type of battery (e.g. a lead-acid battery is replaced with an AGM battery) or a battery with a different capacity (mAh), the vehicle may require reprogramming the new battery type in addition to performing the battery reset. Consult the vehicle manual for additional vehicle-specific information.

Register Battery Replacement

This option allows displaying the mileage reading of last battery replacement, registering the battery replacement after replacing a new battery and informing the power management system that a new battery has been fitted to the vehicle.

If the battery change is not registered, the power management system will not function properly, which may not provide the battery with enough charging power to operate the car and limit the functions of individual electrical equipment.

Take **BMW** as an example.

- **To display the battery history**

1. Tap the **Service** application button from the OtoSys Job Menu.
2. Tap **BMS** button and wait for the vehicle manufacturer screen. You can tap **VIN Scan** or the vehicle make to acquire vehicle VIN information and tap **Yes** to confirm. See [Vehicle Identification](#) on page 24 for details.
3. Tap **Register Battery Replacement** in the EPB function list, the list may vary for different vehicles being tested.



Figure 7-9 Sample BMS Function List

4. Tap on the corresponding service you want to carry out. In this case, it is function 1 **Display kilometer reading at last battery change and one before last**. A notice screen displays.

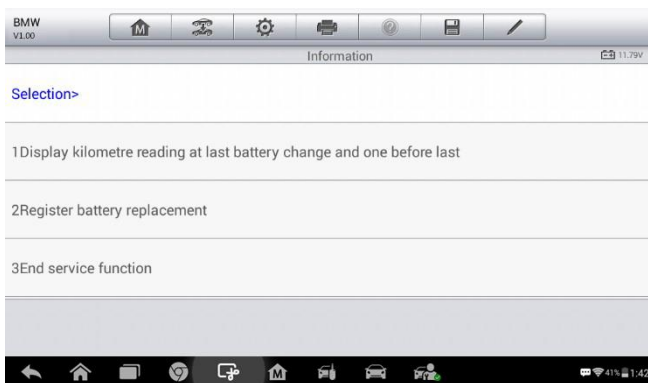

Figure 7-10 Sample BMS Screen 1

5. Read carefully the complete information and press **Continue** to continue.

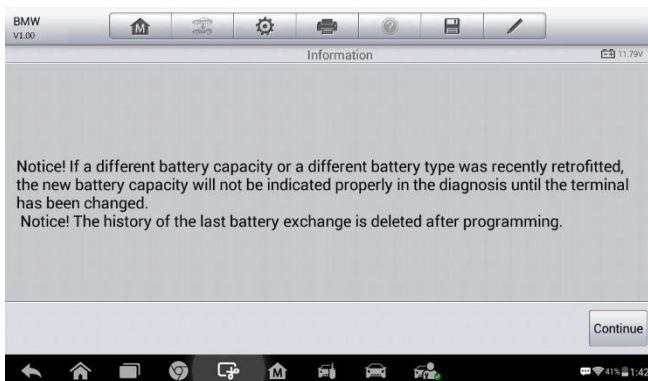

Figure 7-11 Sample BMS Screen 2

6. Check the battery capacity and the battery replacement information on the screen.
7. Tap on the corresponding function 1 to return to the selection screen or press the function 2 to end the service function.

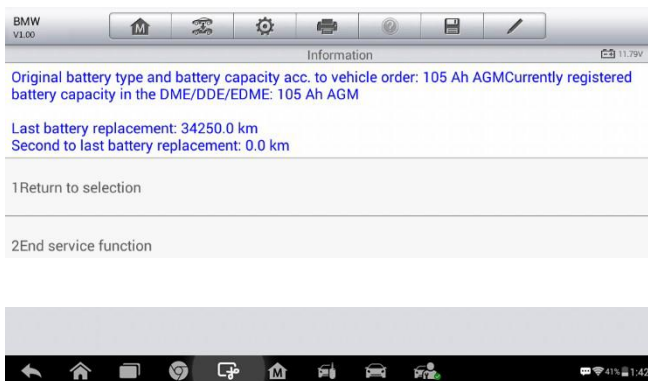

Figure 7-12 Sample BMS Screen 3

- **To register the battery replacement**

1. Tap on the corresponding service you want to carry out. In this case, it is function 2 **Register battery replacement**.

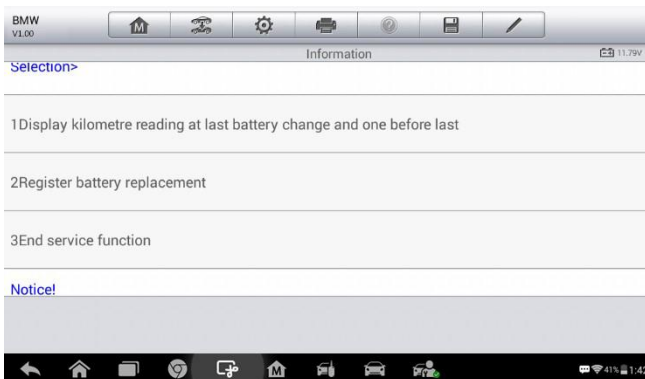

Figure 7-13 Sample BMS Screen 4

2. Read carefully the information on the screen and slide up/down to view all the functions listed.

There are four functions listed:

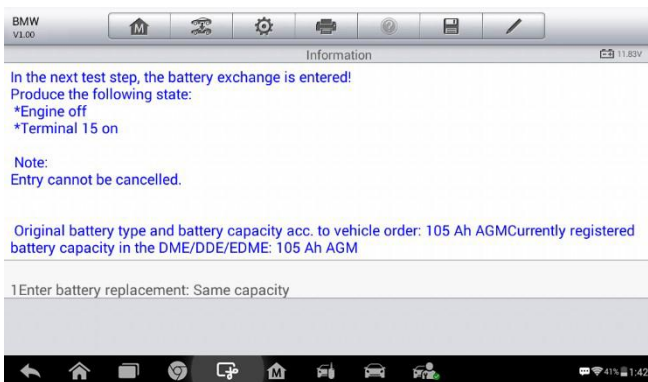

Figure 7-14 Sample BMS Screen 5

- 1) Enter battery replacement: Same capacity
- 2) Enter battery replacement: Different capacity
- 3) Enter battery replacement: Changing from the normal lead-acid battery (white housing) to AGM battery (black housing)

4) End service function.

Take the first function as an example.



Figure 7-15 Sample BMS Screen 6

1. Read carefully the information on the screen and tap **Yes** to continue.
2. Follow the on-screen instructions to input the data matrix code of the newly installed battery which should be on the label of the battery. Tap **OK** to continue.

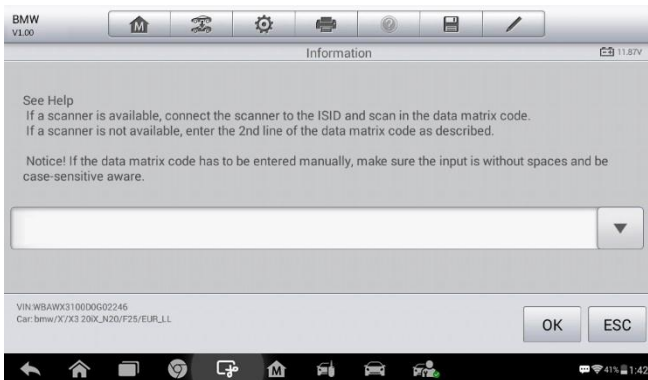

Figure 7-16 Sample BMS Screen 7

3. When the battery exchange is successfully entered, tap **Continue** to complete the operation.

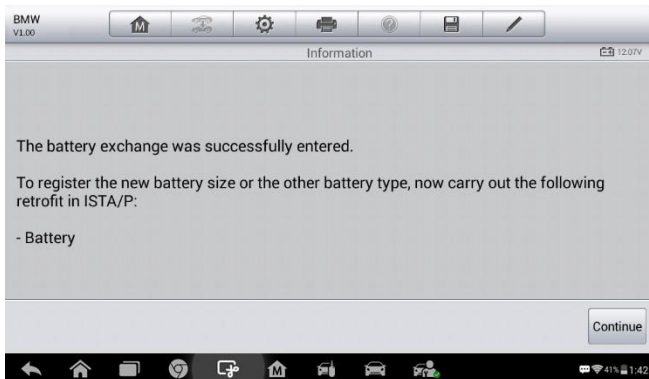

Figure 7-17 Sample BMS Screen 8

Steering Angle Sensor (SAS) Service

Steering Angle Sensor Calibration permanently stores the current steering wheel position as the straight-ahead position in the steering angle sensor EEPROM. Therefore, the front wheels and the steering wheel must be set exactly to the straight-ahead position before calibration. In addition, the vehicle identification number is also read from the instrument cluster and stored permanently in the steering angle sensor EEPROM. On successful completion of calibration, the steering angle sensor fault memory is automatically cleared.

Calibration must always be carried out after the following operations:

- Steering wheel replacement
- Steering angle sensor replacement
- Any maintenance that involves opening the connector hub from the steering angle sensor to the column
- Any maintenance or repair work on the steering linkage, steering gear or other related mechanism
- Wheel alignment or wheel track adjustment
- Accident repairs where damage to the steering angle sensor or assembly, or any part of the steering system may have occurred

NOTE

1. Auro accepts no responsibility for any accident or injury arising from servicing the SAS system. When interpreting DTCs retrieved from the vehicle, always follow the manufacturer's recommendation for repair.
 2. All software screens shown in this manual are examples, actual test screens may vary for each vehicle being tested. Observe the menu titles and on-screen instructions to make correct option selections.
 3. Before starting the procedure, make sure the vehicle has an ESC button. Look for the button on dash.
-

Take **Land Rover** as an example.

1. Tap the **Service** application button from the OtoSys Job Menu.
2. Tap **SAS** button and wait for the vehicle manufacturer screen. You can tap **VIN Scan** or the vehicle make to acquire vehicle VIN information and tap **Yes** to confirm. See [Vehicle Identification](#) on page 24 for details.
3. Tap the service you want in the SAS function list, the list may vary for different vehicles being tested.

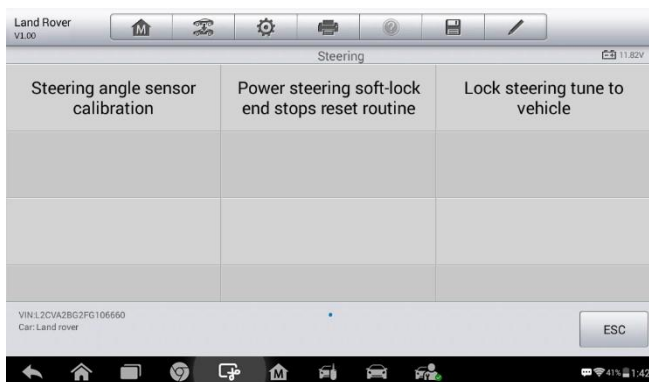

Figure 7-18 Sample SAS Function Menu

Steering Angle Sensor Calibration

This function allows users to perform steering angle sensor calibration and clear records. The function options vary with the vehicles being tested.

- 1) Tap **Steering Angle Sensor Calibration** from the SAS function menu to enter the function screen.
- 2) Follow the on-screen instructions to set the ignition on/off as guided. The vehicle battery voltage signal should be in the range 12.5 – 13.5 volts to proceed this service, otherwise the scan tablet will display a warning message.
- 3) Make sure the steering wheel is in the central position and the front wheels are in the straight position. Then tap **OK** to proceed.

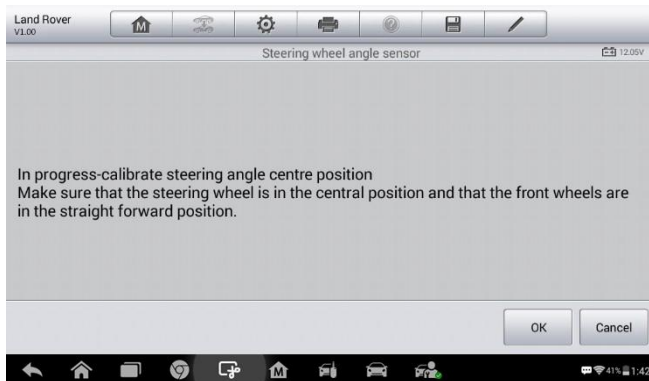

Figure 7-19 Sample SAS Function Screen 1

- 4) When the operation is completely finished, the scan tool will display a confirmation message. Otherwise, it will display a message to remind

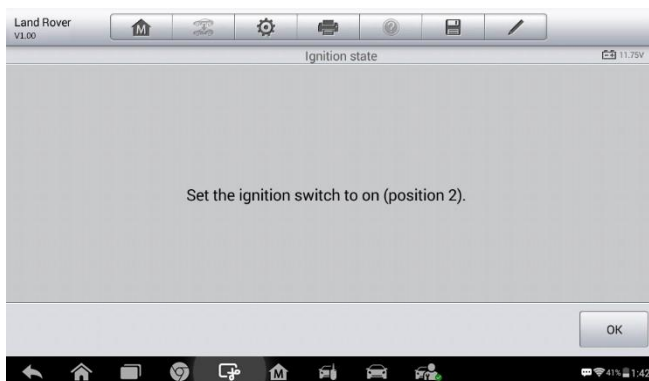

Figure 7-20 Sample SAS Function Screen 2

you of a problem. After you exit the diagnosis program, please repair the problem immediately.

DPF Service

The DPF function allows you to carry out numerous functions to the Diesel Particulate Filter system without having to send your car to a main dealer. The tool will manage DPF regeneration, DPF component replacement teach-in and DPF teach-in after replacing the engine control unit.

ECM monitors driving style and selects a suitable time to employ regeneration. Cars driven a lot at idling speed and low load will attempt to regenerate earlier than cars driven more with high load and high speed. In order for regeneration to take place, a prolonged high exhaust temperature must be obtained.

In the event of the car being driven in such a way that regeneration is not possible, i.e. frequent short journeys, a diagnostic trouble code will eventually be registered, DPF light and “Check Engine” indicator comes on. A service regeneration can be requested in the workshop, using the diagnostic tool.

Before carrying out a forced DPF regeneration using the tool, check the following items:

- The fuel light is not on.
- No DPF-relevant faults stored in system.
- The vehicle has the correct spec engine oil.
- The oil for diesel is not contaminated.

! IMPORTANT

Before diagnosing a problem vehicle and attempting to perform an emergency regeneration, it is important to obtain a full diagnostic log and read out relevant measured value blocks.

🔧 NOTE

1. The DPF will not regenerate if the engine management light is on, or there is a faulty EGR valve.
2. The ECU must be re-adapted when replacing the DPF and when topping up the fuel additive Eolys.

3. If the vehicle needs to be driven in order to perform a DPF service, ALWAYS have a second person help you. One person should drive the vehicle while the other person observes the screen on the Tool. Trying to drive and observe the Scan Tool at the same time is dangerous, and could cause a serious traffic accident.

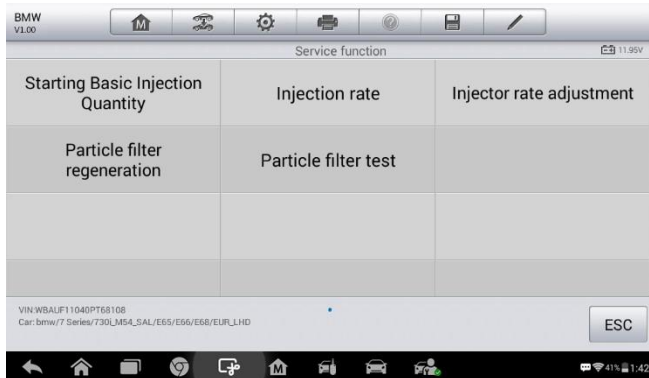

Figure 7-21 Sample DPF Service Function Menu

Starting Basic Inspection Quantity

This function enables you to start fuel delivery matching.

1. Tap **Starting Basic Inspection Quantity** from the service functions menu to enter the service screen.
2. The tool communicates with the vehicle and reads the fault codes memory. Follow the on-screen instructions to finish this procedure.
3. The tool will display a function list menu as below. Press the corresponding number button to perform the desired function.

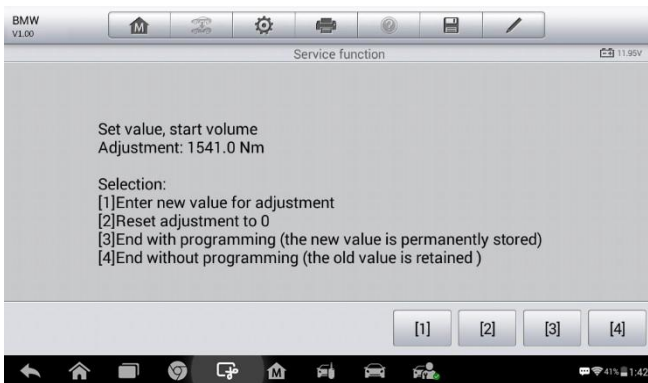

Figure 7-22 Sample Starting Basic Inspection Quantity

[1] Enter New Value for Adjustment

From the **Starting Basic Inspection Quantity** menu, tap **[1]** and the screen displays as below.



Figure 7-23 Sample Enter New Value Screen

After entering the value, tap **OK** to save the value to the tool. Tap **ESC** to exit the operation.

NOTE

The data you input should be in the range given. If the input data is out of range, the tool will display a warning message “Permissible adjustment range exceeded.”

[2] Reset Adjustment to 0

Once the **[2]** is tapped, the tool will automatically reset the value to zero.

[3]/[4] Store Data and Exit

When the fuel delivery rate adjustment is completed, tap **[3]** to store the new value in the control units; or select **[4]** and **OK** to retain the old value.

Injection Rate

This function is used to adjust the injection volume.

1. Tap **Injection Rate** from the service functions menu to enter the service screen.
2. The tool communicates with the vehicle and reads the fault codes memory. Follow the on-screen instructions to finish this procedure.
3. Then the tool will display as below. Press the corresponding number button to perform the desired function.

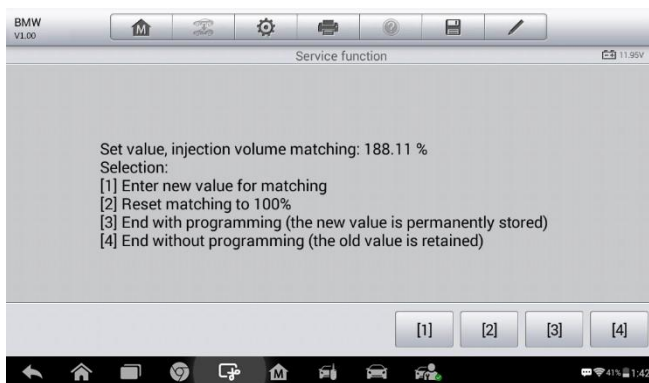

Figure 7-24 Sample Injection Rate Screen

[1] Enter New Value for Adjustment

From the **Injection Rate** menu, tap **[1]** and the screen displays as below.

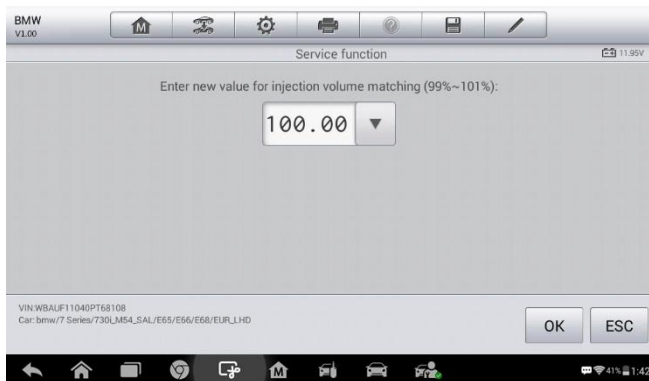

Figure 7-25 Sample Enter Value Screen

NOTE

The data you input should be in the reasonable range. If the input data is out of range, the tool will display a warning message “Permissible adjustment range exceeded.”

[2] Reset Adjustment to 100%

Once the **[2]** is pressed, the tool will automatically reset the value to 100%.

[3]/[4] Store Data and Exit

When the injection volume adjustment is completed, select **[3]** and **OK** to store the new value in the control units; or select **[4]** and **OK** to retain the old value.

Injector Rate Adjustment

This function is used to adjust the injector rate for individual cylinders.

1. Tap **Injection rate adjustment** from the service functions menu.
2. The tool communicates with the vehicle and reads the fault codes memory. Follow the on-screen instructions to enter the service function.
3. Tap the corresponding number button to enter new value for each cylinder.

4. Follow the on-screen instructions to tap on the corresponding number [1] [2] [3] [4] to enter the new value for the cylinder, restore the old value, and exit after finish the function.

Particle Filter Regeneration

This function is used to perform the particle filter regeneration.

1. Tap **Particle filter regeneration** from the service functions menu.
2. The tool communicates with the vehicle and reads the fault codes memory. Follow the on-screen instructions to check the prerequisites before particle filter regeneration, such as the fuel, the time and driving style.
3. If every prerequisite is met, the tool will ask your confirmation to proceed as below. Tap **Request** to begin a regeneration or **End** to end the service function and exit.

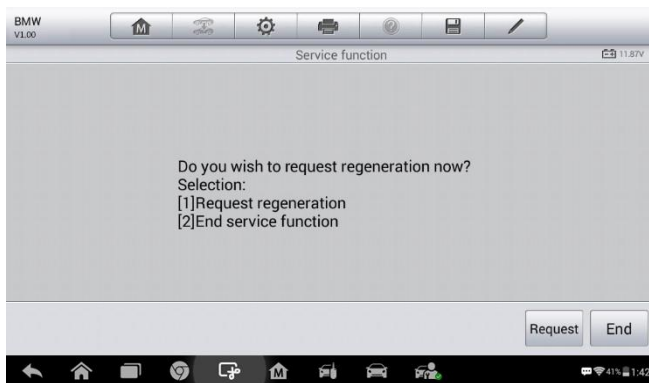

Figure 7-26 Sample Regeneration Confirmation Screen

4. A series of instruction screens appears for users to perform the particle filter regeneration step by step. Follow the onscreen instructions and tap **OK** button until the tool reads off the regeneration status as below.

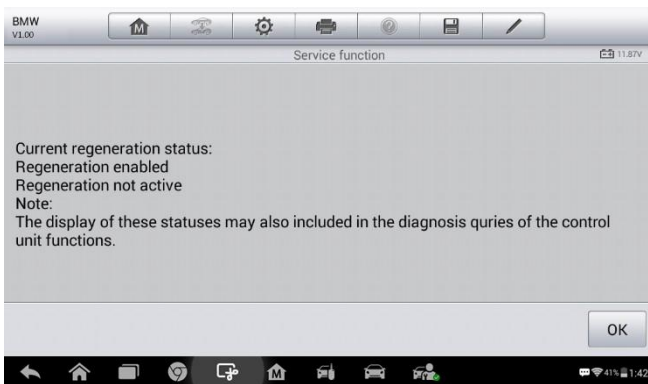

Figure 7-27 Sample Regeneration Status Screen

- When the particle filter regeneration is complete, the tool will ask your confirmation to exit the display. Tap **Repeat** to check the status again or **End** to end the service function and exit.

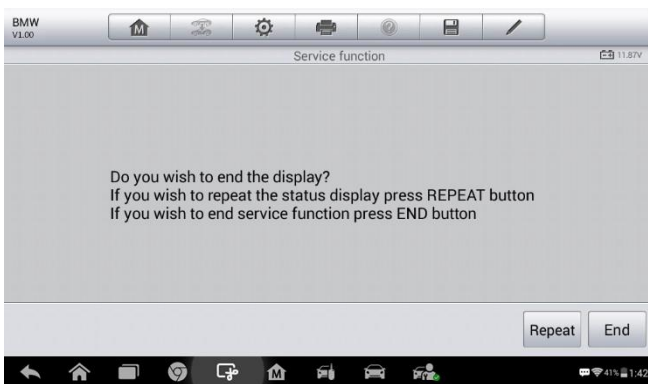

Figure 7-28 Sample Repeat Screen

NOTE

In the case of a particle filter heavily loaded with soot, it can occur that the regeneration request is blocked again after a short time or is not released. In this case, it is required to regenerate the particle filter in a motorway or cross-country trip taking approx. 30 minutes at a speed that is as constant as possible. Subsequently, the service function "Particle filter regeneration" must be run again.

During the regeneration phase and with the engine running, it can also occur that the display for “Regeneration active” jumps to “Regeneration not active”. This behavior can be seen exclusively with the vehicle stationary with the engine.

Particle Filter Test

It is advisable to carry out a series of particle filter tests as a result of constant DPF regeneration, such as checking oil level, oil change interval for diesel contamination, swirl flaps, backpressure sensors and particle filter soot remains.

1. Tap **Particle filter test** from the service functions menu.
2. The tool communicates with the vehicle and reads the fault codes memory. If there is no relevant fault code stored in DDE, the screen displays as below. Select **Cancel** to exit this function.
3. If there are DPF-related codes stored in DDE, the screen displays as below. Select **OK** to continue or **Cancel** to exit this function.

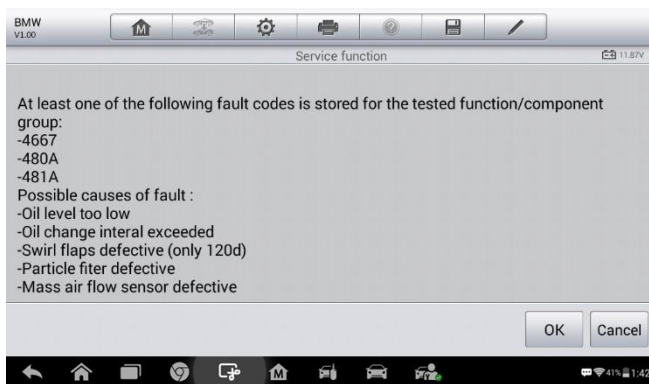

Figure 7-29 Sample Codes Screen

4. The tool shows a list of particle filter test. Select the corresponding number button to perform the desired test **[1] [2] [3] [4] [5]**.

[1] Visual Inspection of Engine Oil

[2] Visual Inspection of Particulate Filter

[3] Function Check or Swirl Flaps

[4] Exhaust Backpressure Test

[5] Actual/Target Value Check-Mass Air Flow Sensor

Tire Pressure Monitor System (TPMS) Service

This function allows you to quickly look up the tire sensor IDs from the vehicle's ECU, as well as to perform TPMS replacement and sensor test.

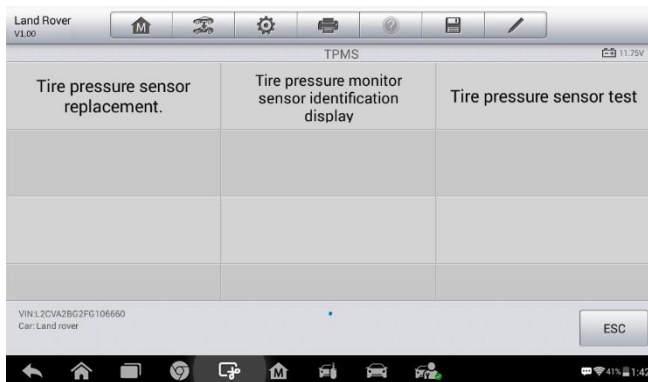

Figure 7-30 Sample TPMS Function Menu

Take Tire pressure sensor replacement (Front left wheel sensor) as an example.

NOTE

During this application the wheel unit 8 digit identifications will need to be entered using the screen displayed.

The sensor identifications can be accessed by reading directly from the wheel unit or by using the identification reading tool.

On completion, a specific road test will be required followed by the tire pressure monitor system application.

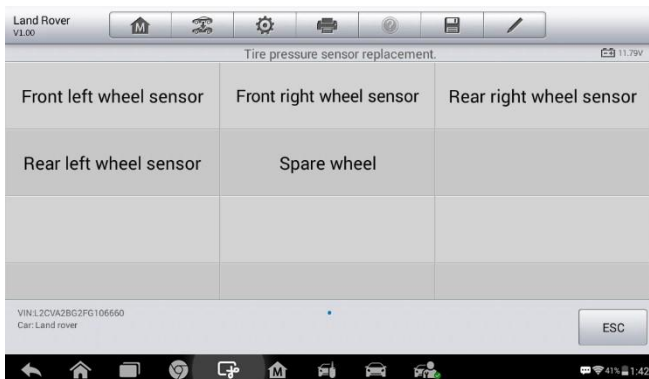

Figure 7-31 Sample Tire Pressure Sensor Replacement Screen

- 1) Tap **Front left wheel sensor** in the tire pressure sensor replacement menu.
- 2) Enter the 8 digit sensor identification as required.

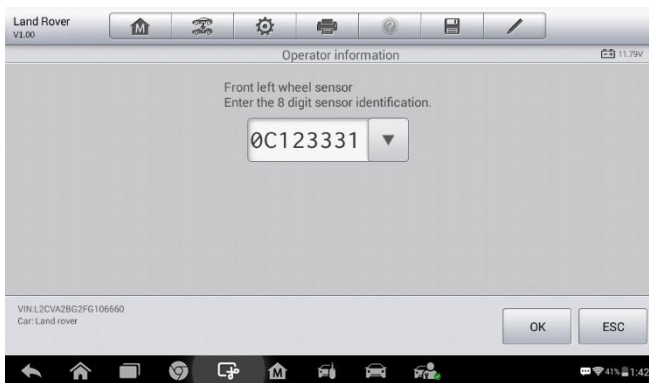

Figure 7-32 Sample Sensor ID Input Screen

- 3) The scan tablet will carry out the service and the screen will remind you the test has passed and all the selected tire pressure sensor identification numbers programmed successfully.

NOTE

The vehicle must remain stationary for at least 15 minutes with the ignition off, this will place the sensors into sleep mode. The vehicle must be driven for at least 15 minutes at a speed higher than 20 kph to ensure the module has learnt the sensor identifications and positions.

For other services, please follow the on-screen instructions to operate.

On completion of the drive cycle, carry out the tire pressure monitor system test application.

8 Update

The Update application allows you to download the latest released software. The updates can improve the OtoSys applications' capabilities, typically by adding new tests, new models, or enhanced applications to the database.

The Display Tablet automatically searches for available updates for all of the OtoSys software when it is connected to the Internet. Any updates that are found can be downloaded and installed on the device. This section describes installing an update to the OtoSys System. A notification message displays if an update is available when the Notifications Center function is enabled in the Settings application.

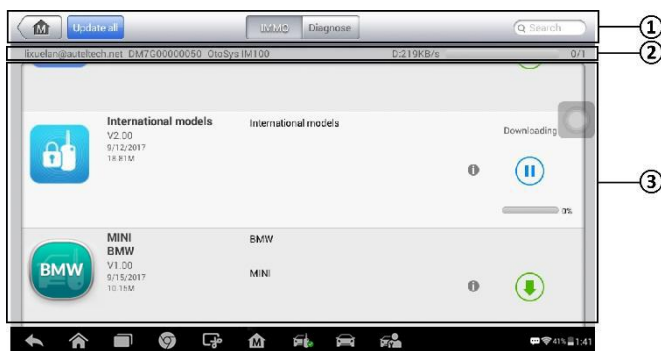

Figure 8-1 Sample Update Screen

1. Navigation and Controls

- Home Button – returns to the OtoSys Job Menu.
- Update All – available updates for all tablet systems.
- IMMO Tab – displays all available IMMO software for vehicles.
- Diagnostics Tab – displays all available vehicle diagnostic softwares.
- Search Bar – search specific update item by inputting the file name, for example: a specific vehicle manufacturer.

2. Status Bar

- Left Side – displays the OtoSys device model information and serial number.
- Right Side – displays an update progress bar indicating the completion status.

3. Main Section

- Left Column – displays vehicle logos and update software version information; tap the **About** button displays a function list in PDF showing more details about the software.
- Middle Column – displays a brief introduction about the new changes to the software operation or capabilities. Tap  button to display an information screen to view more details, and tap the dim area around to close the window.
- Right Column – according to the operation status of each software item, the button displays differently.
 - a) Tap **Update** to update the selected item.
 - b) Tap **Pause** to suspend the updating procedure.
 - c) Tap **Continue** to go on updating the suspended update.

➤ To update the diagnostic software and TPMS service software

1. Make sure the Display Tablet is connected to a power source with stable access to the Internet.
2. Tap the **Update** application button from the OtoSys Job Menu; or tap the update notification message when received one; or tap the **Update** icon on Vehicle Menu in Diagnostics application. The Update application screen displays.
3. Check all available updates:
 - If you decide to update all the items of IMMO software, select **IMMO** Tab and then tap the **Update All** button; if you want to update all items of diagnostic software, select **Diagnose** Tab and then tap the **Update All** button.
 - If you only want to update one or some of the item(s), tap the **Update** button on the right column of the specific item(s).
4. Tap the **Pause** button to suspend the updating process. Tap **Continue** to resume the update and the process will continue from the pause point.

5. When the updating process is completed, the firmware will be installed automatically. The new version will replace the older version.

9 Settings

Selecting Settings application opens a setup screen, on which you can adjust default setting and view information about the OtoSys system. There are nine options available for the OtoSys system settings:

- **Unit**
- **Language**
- **Printing Setting**
- **Firmware Upgrade**
- **Notification Center**
- **Multitask**
- **Auto Update**
- **System Settings**
- **About**

This section describes the operation procedures for the settings.

Unit

This option allows you to adjust the measurement unit for the diagnostic system.

➤ **To adjust the unit setting**

1. Tap the **Settings** application on the OtoSys Job Menu.
2. Tap the **Unit** option on the left column.
3. Select the required measurement unit, Metric or English. A check mark will display to the right of the selected unit.
4. Tap the **Home** button on the top left corner to return to the OtoSys Job Menu. Or select another setting option for system setup.

Language

This option allows you to adjust the display language for the OtoSys system.

➤ **To adjust the language setting**

1. Tap the **Settings** application on the OtoSys Job Menu.
2. Tap the **Language** option on the left column.
3. Select the required language. A check mark will display to the right of the selected language.
4. Tap the **Home** button on the top left corner to return to the OtoSys Job Menu. Or select another setting option for system setup.

Printing Setting

This option allows you to print any data or information anywhere and anytime via Wi-Fi connection.

➤ **To setup the printer connection**

1. Tap the **Settings** application on the OtoSys Job Menu.
2. Tap the **Printing Setting** option on the left column.
3. Tap the **Print via Network** item to activate the printing function, which enables the device to send files to the printer through the PC via Wi-Fi connection.
4. Tap the **Home** button on the top left corner to return to the OtoSys Job Menu. Or select another setting option for system setup.

 **NOTE**

The **Auro Printer** runs automatically after the installation. Before printing make sure the Display Tablet is connected to the same network with the computer, either via Wi-Fi or LAN. And the computer is connected to a printer.

➤ **To perform printing via PC**

1. Run the **Auro Printer** on the computer.
2. Click **Test Print** to make sure the printer is working successfully.
3. Tap the **Print** button on the toolbar of the Display Tablet. A temporary document will be created and sent to the computer.

- ✧ If the **Auto Print** option in the Auro Printer is selected, the Auro Printer will print the received document automatically.
- ✧ If the **Auto Print** option is not selected, click **Open PDF File** button to view all the temporary files. Select the file(s) you want to print and click **Print**.

➤ **To perform printing via APP**

If a Wi-Fi printer is available, please purchase a Wi-Fi printer APP and install it onto your Display Tablet. By a simple click on the **Print** button of a saved file on the Display Tablet, the file will be printed automatically.

Firmware Upgrade

This option allows you to update the firmware of the built-in VCI module and the UP200.

- Connect the tablet and the vehicle with the supplied main cable, ensure the tablet is connected to the Internet. The built-in VCI module will be automatically upgraded if a firmware update is available.
- Connect the UP200 with the tablet through the supplied USB cable and ensure the tablet is connected to the Internet. The UP200 will be automatically upgraded if a firmware update is available. Disconnect the UP200 and the tablet after upgrading and then reconnect them to continue operations.

Notification Center

This option allows you to turn the Notification Center function on or off. The Notification Center function configures the OtoSys tablet to receive regular on-line messages from the server for system update notifications or other service information via the Internet. It is highly recommended to keep this function on all the time, so you won't miss out any new update for OtoSys or event from Auro. Internet access is required for receiving on-line messages.

➤ **To enable the Notification Center function**

1. Tap the **Settings** application on the OtoSys Job Menu.

2. Tap the **Notification Center** option on the left column.
3. Tap the **ON/OFF** button to enable or disable the Notifications function. If the function is enabled the button displays blue, or if disabled the button displays gray.
4. Tap the **Home** button on the top left corner to return to the OtoSys Job Menu. Or select another setting option for the system setup.

When the Notification Center function is turned on, and new messages are received by the OtoSys device, a notification message displays on the OtoSys Job Menu. Press on the message bar and drag it down to display a list of received messages. Slide the list up or down to view additional message if present,

Tapping a specific message launches the corresponding application. For example, if you tap on an Update notification message, the Update application will be launched.

Multitask

The Multitask option allows you to turn the Multitask function on or off. The Multitask feature enables you to browse and navigate more freely among different applications on the OtoSys system. Tap the Multi Task button, the Multi Task menu displays all active applications.

➤ To enable the Multitask function

1. Tap the **Settings** application on the OtoSys Job Menu.
2. Tap the **Multitask** option on the left column.
3. Tap the **ON/OFF** button to enable or disable the Multitask function. If the function is enabled the button displays blue, or if disabled the button displays gray.
4. Tap the **Home** button on the top left corner to return to the OtoSys Job Menu. Or select another setting option for the system setup.

Auto Update

The Auto Update allows the tool to automatically update the OS, the OtoSys system, and the vehicle software. All you need to do is to switch ON by

tapping the button on the right side of each and set the desired automatic update time.

➤ **To set auto system or vehicle update**

1. Tap the **Settings** application on the OtoSys Job Menu.
2. Tap the **Auto Update** option on the left column. The three auto update items list on the right.
3. Switch the ON the button on the right of item that you want to auto update.
4. Tap on the time to set time, you can use the **+** and **-** button or tap on the numbers then the manual input screen will pop up. Tap **Done** to complete the time setting.

 **NOTE**

Internet connection is necessary for auto update, otherwise it would not work even if you have already switch it on. Make sure the tool is connected to the Internet for the time you have set.

System Settings

This option provides you a direct access to the Android background system setting screen, on which you can adjust various system settings for the Android system platform, regarding wireless and networks settings, various device settings such as display, system security settings, and check the associated information about the Android system.

➤ **To enable the App Switcher function**

1. Tap the **Settings** application on the OtoSys Job Menu.
2. Tap the **System settings** option on the left column.
3. Tap the **App Switcher** option on the left column.
4. Mark the checkbox beside “Always show the App Switcher” on the right side of the screen, then the App Switcher icon shows.

Short pressing the App Switcher icon opens a control panel:

- Tapping a specific app shortcut button enables you to switch directly to

the selected application screen.

- Long pressing a specific app shortcut button displays the app menu, on which you can select and change the app shortcut.
- Pressing and dragging the App Switcher icon around allows you to change the icon position alongside the edge of the screen.

You may refer to Android documentation for additional information about Android system settings.

About

The About option provides information of the OtoSys diagnostic device regarding the product name, version, hardware, and serial number.

- **To check the OtoSys product information in About**
 1. Tap the **Settings** application on the OtoSys Job Menu.
 2. Tap the **About** option on the left column. The product information screen displays on the right.
 3. Tap the **Home** button on the top left corner to return to the OtoSys Job Menu, or select another setting option for the system setup after viewing.

10 Remote Desk

The Remote Desk application launches the TeamViewer Quick Support program, which is a simple, fast and secure remote control screen. You can use the application to receive ad-hoc remote support from Auro's support center, colleagues, or friends, by allowing them to control your OtoSys tablet on their PC via the TeamViewer software.

If you think of a TeamViewer connection as a phone call, the TeamViewer ID would be the phone number under which all TeamViewer Clients can be reached separately. Computers and mobile devices that run TeamViewer are identified by a globally unique ID. The first time the Remote Desk application is started, this ID is generated automatically based on the hardware characteristics and will not change.

Make sure the Display Tablet is connected to the Internet before launching the Remote Desk application, so that the Display Tablet is able to receive remote support from the third party.

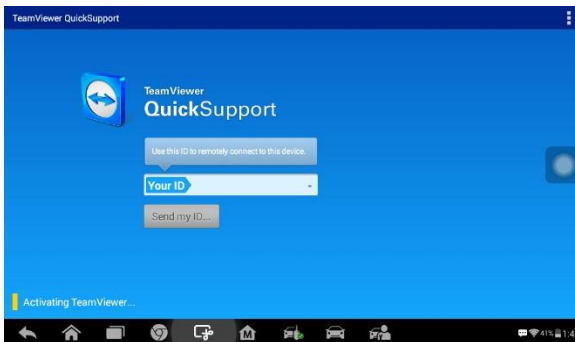

Figure 10-1 Sample Remote Desk Screen

- **To receive remote support from a partner**
 1. Power on the Display Tablet.
 2. Tap the **Remote Desk** application on the OtoSys Job Menu. The TeamViewer screen displays and the device ID is generated and

shown.

3. Your partner must install the Remote Control software to his/her computer by downloading the TeamViewer full version program online (<http://www.teamviewer.com>). Start the software on his/her computer at the same time, in order to provide support and take control of the Display Tablet remotely.
4. Provide your ID to the partner, and wait for him/her to send you a remote control request.
5. A message displays to ask for your confirmation to allow remote control on your device.
6. Tap **Allow** to accept, or tap **Deny** to reject.

Refer to the associated TeamViewer documents for additional information.

11 Data Manager

The Data Manager application is used to store, print, and review the saved files. Most operations are controlled through the toolbar.

Selecting the Data Manager application opens the file system menu. Different file types are sorted separately under different options, there are five types of information files to be viewed or played back.



Figure 11-1 Sample Data Manager Main Screen

Operations

Data Manager Operations are based on toolbar controls. Details are explained in the following sections.

Image Files







The Image section contains all captured screenshot images.



Figure 11-2 Sample Image Screen

1. **Toolbar Buttons** – used to edit, print and delete the image files. See the following table for detailed information.
2. **Main Section** – displays the stored images.

Table 11-1 Toolbar Buttons in Image

Button	Name	Description
	Back	Return to the previous screen.
	Enter Edit	Tap to display the editing toolbar to print, delete or view image information.
	Cancel	Tap to close the editing toolbar or cancels file search.
	Search	Quickly locates the image file by entering the vehicle name, test path, file name or file info.
	Info	Tap to open a window displaying the details of the image.
	Print	Tap to print the selected image.

	Delete	Tap to delete the selected image.
---	---------------	-----------------------------------

➤ **To edit image information**

1. Select **Data Manager** application from the OtoSys Job Menu.
2. Select **Image** to access the image database.
3. Select an image to display it in full screen.
4. Tap the screen to display the editing toolbar.
5. Tap the **Info** button to open a window displaying the image information.
6. Tap the **Edit** button on the top right corner of the window. The editing screen displays.
7. Edit the image information by entering the new file name, and file information.
8. Tap **Done** to save the information and exit, or tap **Cancel** to exit without saving.

 **NOTE**

To realize the wireless data printing function, you need to install the printer driver program.

➤ **To install the printer driver program**

1. Please download the **Auro PC Suite** from www.aurodiag.com > Support & Updates > Firmware & Downloads > UPDATE CLIENT, and install to your PC. The Auro PC Suite consists of Auro Printer, and Auro PC Suite.
2. Double click on **Setup.exe** item.
3. Select the installation language and the printer driver installation wizard will load momentarily.
4. Follow the wizard instructions on the screen and click **Next** to continue.

5. Click on **Install** and the printer driver program will be installed onto the computer.
 6. Click on **Finish** to complete the whole installation procedure.
- **To delete selected images**
1. Select **Data Manager** application from the OtoSys Job Menu.
 2. Select **Image** to access the JPG database.
 3. Tap the **Enter Edit** button to display the editing toolbar.
 4. Select the images that need to be deleted by tapping the thumbnail images, the selected thumbnail displays a check mark at the bottom right corner.
 5. Tap the **Delete** button, and then **Delete Selected**, then the selected images will be deleted.

PDF Files

The PDF section stores and displays all PDF files of saved data. After entering the PDF database, select a PDF file to view the stored information.

This section uses the standard Adobe Reader application for file viewing and editing. Please refer to the associated Adobe Reader manual for more detailed instructions.

Review Data

The Review Data section allows you to playback the recorded data frames of live data streams.

On the Review Data main screen, select a record file to playback.

Name	Value	Unit
<input type="checkbox"/> BUS Power Mode	Accessory	
<input type="checkbox"/> Transport Mode	Active	
<input type="checkbox"/> Vehicle Speed	0	km/h
<input type="checkbox"/> Vehicle Speed (CAN-Bus)	0	km/h
<input type="checkbox"/> Engine Speed	782	rpm
<input type="checkbox"/> OverSpeed Warning	Off	
<input type="checkbox"/> OverSpeed Function	Inactive	
<input type="checkbox"/> OverSpeed Buzzer	Enabled	
<input type="checkbox"/> Displayed Fuel Level	5	%

Figure 11-3 Sample Data Playback Screen

1. **Drop-down Toolbar** – tap the button at the top center of the screen to open the Drop-down Toolbar.
2. **Main Section** – displays the recorded data frames.
3. **Navigation Toolbar** – allows you to manipulate data playback.

Use the Navigation Toolbar buttons to playback the record data from frame to frame. Tap **Back** to exit data playback.

Apps Uninstall

This section allows you to manage the firmware applications installed on the OtoSys Diagnostics System. Selecting this section opens a managing screen, on which you can check all the available vehicle diagnostic applications.

Select the vehicle firmware you want to delete by tapping on the car brand icon, the selected item will display a blue check mark at the upper right corner. Tap the **Delete** button on the top bar to delete the firmware from the system database.

Data Logging

The Data Logging section allows you to launch Support platform directly to view all records of all sent or unsent (saved) data loggings on the diagnostic system.









12 Shop Manager



The Shop Manager application helps you manage the workshop information, customer information records, and keep test vehicle history records, which can help in dealing with daily workshop business and improves customer service. There are three main functions available:

- **Vehicle History**
- **Workshop Information**
- **Customer Manager**

The operations of these functions are mainly manipulated by the toolbar buttons, which are listed and described in the table below:

Table 12-1 Top Toolbar Buttons in Shop Manager

Button	Name	Description
	Back	Return to the previous screen.
	Diagnostics	Tap to display the Diagnostics screen to activate a direct test session.
	Enter Edit	Tap to display the editing toolbar to print or delete the selected file.
	Delete	Tap to delete the selected vehicle record item from the list.
	Search	Quickly locates the vehicle record by entering the vehicle name or test path.
	Cancel	Tap to cancel edit or file search.
	Edit	Tap to edit information for the displayed file.
	Add Account	Tap to create a new customer account file.

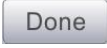
Button	Name	Description
	History Notes	Tap to open a note form, which allows you to create audio record, attach picture or video, or edit text notes.
	Vehicle History	Tap to open the Vehicle History screen which displays the correlated test vehicle records.
	Done	Complete editing and save the file.

Vehicle History

This function stores records of test vehicle history, including vehicle information and the retrieved DTCs from previous diagnostic sessions. Test information is summarized and displayed in an easy-to-view table listing. The Vehicle History also provides direct access to the previously tested vehicle and allows you to restart a diagnostic session without the need to do vehicle identification again.



Figure 12-1 Sample Vehicle History Screen

1. **Top Toolbar Buttons** – navigation and application controls.
 2. **Main Section** – displays all the vehicle history records.
- **To activate a test session for the recorded vehicle**

1. Tap the **Shop Manager** application on the OtoSys Job Menu.
2. Select **Vehicle History**
3. Tap the **Diagnostics** button at the bottom of the thumbnail of a vehicle record item. Or,
4. Select a vehicle record item by tapping the thumbnail.
5. A Historical Test record sheet displays, check the recorded information of the recorded test vehicle, and tap the Diagnostics button on the upper right corner.
6. The vehicle's Diagnostics screen displays and a new diagnostic session is activated, see *Diagnosis* on page 42 for detailed instructions on vehicle diagnostic operations.

Historical Test Record

The Historical Test record of the tested vehicle is a detailed data form, which includes all general information of the vehicle such as vehicle year, make and model and the diagnostic trouble codes retrieved from the previous test sessions, as well as other service details that can be added manually by the technician himself.



Figure 12-2 Sample Historical Test Record Sheet

➤ To edit the Historical Test record

1. Tap the **Shop Manager** application on the OtoSys Job Menu.

2. Select **Vehicle History**.
3. Select the specific vehicle history record thumbnail from the main section. The Historical Test record will display.
4. Tap the **Edit** button to start editing.
5. Tap on each item to input the corresponding information or attach files or images.

 **NOTE**

The vehicle VIN number, license number or customer account information are correlated by default. Adding one of these IDs will automatically be associated with the other ID on the test record.

6. Tap **Add to Customer** to correlate the Historical Test record sheet to an existing customer account, or add a new associated account to be correlated with the test vehicle record. See [Customer Manager](#) on page 106 for more information.
7. Tap **Done** to save the updated record, or tap **Cancel** to exit without saving.

Workshop Information

The Workshop Information form allows you to input, edit, and save the detailed workshop information, such as shop name, address, phone number and other remarks, which, when printing vehicle diagnostic reports and other associated test file, will display as the header of the printed documents.

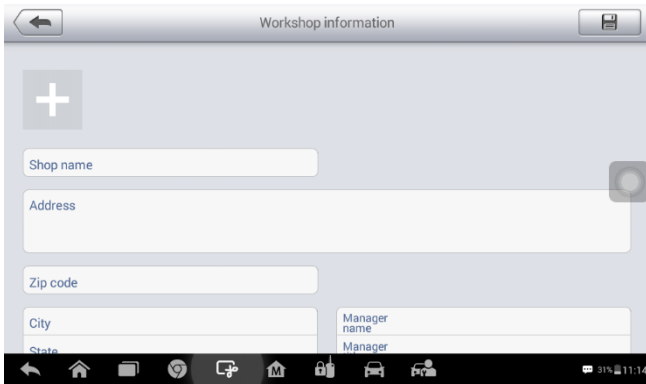

Figure 12-3 Sample Workshop Information Sheet

- **To edit the Workshop Information sheet**
 1. Tap the **Shop Manager** application on the OtoSys Job Menu.
 2. Select **Workshop Information**.
 3. Tap the **Edit** button on the top toolbar.
 4. Tap on each field to input the appropriate information.
 5. Tap **Done** to save the updated workshop information record, or tap **Cancel** to exit without saving.

Customer Manager

The Customer Manager function allows you to create and edit customer accounts. It helps you to save and organize all customer information accounts that are correlated with the associated test vehicle history records.

- **To create a customer account**
 1. Tap the **Shop Manager** application on the OtoSys Job Menu.
 2. Select **Customer Manager**.
 3. Tap the **Add Account** button. An empty information form displays, tap each field to input the appropriate information.

 **NOTE**

The items that must be filled are indicated as required fields.

4. Tap the cross mark beside the Name chart to add a photo. A sub menu displays, select **Take Photo** to take a new photo for the account, or select **Choose Photo** to choose from the existing files.
5. Some customers may have more than one vehicle for service; you can always add new vehicle information to the account. Tap **Add New Vehicle Information**, and then fill in the vehicle information. Tap the  button to cancel.
6. Tap **Done** to save the account, or tap **Cancel** to exit without saving.

➤ **To edit a customer account**

1. Tap the **Shop Manager** application on the OtoSys Job Menu.
2. Select **Customer Manager**.
3. Select a customer account by tapping the corresponding name card. A Customer Information record displays.
4. Tap the **Edit** button on the top toolbar to start editing.
5. Tap on the input field to edit or amend information, and enter updated information.
6. Tap **Done** to save the updated information, or tap **Cancel** to exit without saving.

➤ **To delete a customer account**

1. Tap the **Shop Manager** application on the OtoSys Job Menu.
2. Select **Customer Manager**.
3. Select a customer account by tapping the corresponding name card. A Customer Information record displays.
4. Tap the **Edit** button on the top toolbar to start editing.
5. Tap the **Delete Customer Information** button. A confirmation message displays.

6. Tap **OK** to confirm the command, and the account is deleted. Tap **Cancel** to cancel the request.

History Notes

The History Notes function allows you to add audio and video records, text notes and photos, for the associated customer account, helpful when dealing with repeat customers. The note-keeping function is a good method to organize customer and vehicle data. This option will display once a customer record is filed.

➤ To access History Notes

1. Tap the **Shop Manager** application on the OtoSys Job Menu.
2. Select **Customer Manager** or **Vehicle History**.
3. Select a customer account by tapping the corresponding name card. A Customer Information sheet displays (if **Customer Manager** is selected). Or, select a vehicle history record to open the Historical vehicle record (if **Vehicle History** is selected).
4. Tap the **History Notes** button on the top bar. The History Notes screen displays.











Figure 12-4 Sample History Notes Screen

1. **Functional Buttons** – navigation and function controls.

2. **Main Section** – displays the note list on the left column and the detail information of the selected note on the right column

Table 12-2 Function Buttons in History Notes

Button	Name	Description
	Back	Return to the previous screen.
	Delete	Tap to delete the selected note.
	Search	Quickly locate a note by entering related text.
	Cancel	Tap to cancel edit or file search.
	Edit	Tap to open an edit window edit notes and attach files.
	Add Notes	Tap to add new note in History Notes.
	Add Photos	Tap to locate and add image to History Notes.
	Save	Save notes.

➤ **To add a note in History Notes**

1. Access History Notes.
2. Tap the **Add Notes** button. An edit window displays.
3. Tap on the Title bar to input a note title.
4. Tap on the blank space below to edit a text note or remark.
5. Select a function button on the top to add files in any form you choose.
6. Tap **Save** to save the note; tap **Discard** or **Cancel** to exit without saving.

13 Maintenance and Service

Maintenance Instructions

The following shows how to maintain your devices, together with precautions to take.

- Use a soft cloth and alcohol or a mild window cleaner to clean the touch screen of the tablet.
- Do not use any abrasive cleansers, detergent, or automotive chemicals to the tablet.
- Maintain the devices in dry conditions and keep them within normal operating temperatures.
- Dry your hands before using the tablet. The touch screen of the tablet may not work if the touch screen is moist, or if you tap the touch screen with wet hands.
- Do not store the devices in humid, dusty or dirty areas.
- Check the housing, wiring, and connectors for dirt and damage before and after each use.
- At the end of each work day, wipe the device housing, wiring, and connectors clean with a damp cloth.
- Do not attempt to disassemble your tablet or the VCI unit.
- Do not drop or cause severe impact to the devices.
- Use only authorized battery chargers and accessories. Any malfunction or damage caused by the use of unauthorized battery charger and accessories will void the limited product warranty.
- Ensure that the battery charger does not come in contact with conductive objects.
- Do not use the tablet beside microwave ovens, cordless phones and some medical or scientific instruments to prevent signal interference.

Troubleshooting Checklist

A. When the Display Tablet does not work properly:

- Make sure the tablet has been registered online.
- Make sure the system software and diagnostic application software are properly updated.
- Make sure the tablet is connected to the Internet.
- Check all cables, connections, and indicators to see if the signal is being received.

B. When battery life is shorter than usual:

- This may happen when you are in an area with low signal strength. Turn off your device if it is not in use.

C. When you cannot turn on the tablet:

- Make sure the tablet is connected to a power source or the battery is charged.

D. When you are unable to charge the tablet:

- Your charger may be out of order. Contact your nearest dealer.
- You may be attempting to use the device in an overly hot/cold temperature. Charge the device in a cooler or warmer area.
- Your device may have not been connected to the charger properly. Check the connector.

NOTE

If the problems persist, please contact Auro's technical support personnel or your local selling agent.

About Battery Usage

Your tablet is powered by a built-in Lithium-ion Polymer battery. This means that, unlike other forms of battery technology, you can recharge your battery while some charge remains without reducing your tablet's autonomy due to the "battery memory effect" inherent in those technologies.

 **DANGER**

The built-in Lithium-ion Polymer battery is factory replaceable only; incorrect replacement or tampering with the battery pack may cause an explosion. Do not use a damaged battery charger.

- Do not disassemble or open crush, bend or deform, puncture or shred.
- Do not modify or remanufacture, attempt to insert foreign objects into the battery, expose to fire, explosion or another hazard.
- Use only the included charger and USB cables. Failure to use Autel-authorized charger and/or USB cables, may result in device malfunction or failure.
- Use of an unqualified battery or charger may present a risk of fire, explosion, leakage, or another hazard.
- Avoid dropping the tablet. If the tablet is dropped, especially on a hard surface, and the user suspects damage, take it to a service center for inspection.
- The closer you are to your network's wireless router, the longer your tablet usage time because less battery power is consumed for the connection.
- The battery recharging time varies depending on the remaining battery capacity.
- Battery life inevitably shortens over time.
- Since overcharging may shorten battery life, remove the tablet from its charger once it is fully charged. Unplug the charger, once charging is complete.
- Leaving the tablet in hot or cold places, especially inside a car in summer or winter, may reduce the capacity and life of the battery. Always keep the battery within normal temperatures.

14 Compliance Information

FCC Compliance

FCC ID: 2AN27OTOSYSIM100

This device complies with Part 15 of the FCC rules and Industry Canada's license-exempt RSSs. Operation is subject to the following two conditions:

1. This device may not cause harmful interference.
2. This device must accept any interference received, including interference that may cause undesired operation.

Cet appareil est conforme aux CNR exempts de licence d'Industrie Canada. Son fonctionnement est soumis aux deux conditions suivantes:

1. Ce dispositif ne peut causer des interférences; et
2. Ce dispositif doit accepter toute interférence, y compris les interférences qui peuvent causer un mauvais fonctionnement de l'appareil.

WARNING

Changes or modifications not expressly approved by the party responsible for compliance could void the user's authority to operate the equipment.

NOTE

This equipment has been tested and found to comply with the limits for a Class B digital device, pursuant to Part 15 of the FCC Rules. These limits are designed to provide reasonable protection against harmful interference in a residential installation.

This equipment generates uses and can radiate radio frequency energy and, if not installed and used in accordance with the instructions, may cause harmful interference to radio communications. However, there is no guarantee that interference will not occur in a particular installation. If this equipment does cause harmful interference to radio or television reception, which can be determined by turning the equipment off and on, the user is encouraged to try to correct the interference by one or more of the following measures:

- Reorient or relocate the receiving antenna.

- Increase the separation between the equipment and receiver.
- Connect the equipment into an outlet on a circuit different from that to which the receiver is connected.
- Consult the dealer or an experienced radio/TV technician for help.

Changes or modifications not expressly approved by the party responsible for compliance could void the user's authority to operate the equipment.

SAR

The radiated output power of this device is below the FCC radio frequency exposure limits. Nevertheless, the device should be used in such a manner that the potential for human contact is minimized during normal operation.

The exposure standard for wireless devices employs a unit of measurement known as the Specific Absorption Rate, or SAR. The SAR limit set by the FCC is 1.6 W/Kg. Tests for SAR are conducted using standard operating positions accepted by the FCC with the device transmitting at its highest certified power level in all tested frequency bands.

Although the SAR is determined at the highest certified power level, the actual SAR level of the device while operating can be well below the maximum value. This is because the device is designed to operate at multiple power levels so as to use only the power required to reach the network. To avoid the possibility of exceeding the FCC radio frequency exposure limits, human proximity to antenna should be minimized.

RF WARNING STATEMENT

The device has been evaluated to meet general RF exposure requirement. The device can be used in portable exposure condition without restriction.

The term "IC" before the radio certification number only signifies that IC technical specifications were met.

RoHS COMPLIANCE

This device is declared to be in compliance with the European RoHS Directive 2011/65/EU.

CE COMPLIANCE

This product is declared to conform to the essential requirements of the following Directives and carries the CE mark accordingly:

EMC Directive 2014/30/EU

R&TTE Directive 1999/5/EC

Low Voltage Directive 2014/35/EU

15 Warranty

Limited One Year Warranty

Shenzhen HC Tech CO., Ltd. (the Company) warrants to the original retail purchaser of this OtoSys Diagnostic Device, that should this product or any part thereof during normal consumer usage and conditions, be proven defective in material or workmanship that results in product failure within one (1) year period from the date of purchase, such defect(s) will be repaired, or replaced (with new or rebuilt parts) with Proof of Purchase, at the Company's option, without charge for parts or labor directly related to the defect(s).

The Company shall not be liable for any incidental or consequential damages arising from the use, misuse, or mounting of the device. Some states do not allow limitation on how long an implied warranty lasts, so the above limitations may not apply to you.

This warranty does not apply to:

- a) Products subjected to abnormal use or conditions, accident, mishandling, neglect, unauthorized alteration, misuse, improper installation or repair or improper storage;
- b) Products whose mechanical serial number or electronic serial number has been removed, altered or defaced;
- c) Damage from exposure to excessive temperatures or extreme environmental conditions;
- d) Damage resulting from connection to, or use of any accessory or other product not approved or authorized by the Company;
- e) Defects in appearance, cosmetic, decorative or structural items such as framing and non-operative parts.
- f) Products damaged from external causes such as fire, dirt, sand, battery leakage, blown fuse, theft or improper usage of any electrical source.

! **IMPORTANT**

All contents of the product may be deleted during the process of repair. You should create a back-up copy of any contents of your product before any repair services.
